



PRODUCT CATALOGUE

February 2025

AK Medical S.r.l.

Legal & operative site | Via del Chioso 8/10 - 24030 Mozzo (BG) Italy

VAT number | 02484810391

Contacts | Tel. 035 613712 - Cell: 334 1807240

E-mail: info@akmedical.it

Web site | www.akmedical.it

LinkedIn | www.linkedin.com/company/ak-medical-s-r-l/

REV 0.0

Our history

It was 2013, a year that was marked by some historical events of relevance: Pope Benedict XVI announced his resignation, Nelson Mandela died, Croatia joined the European Union. Among these memorable moments, there is the birth of a young company: AK Medical. This last name must be the event that most struck you thinking about 2013, if not, I would say that it is time to get to know each other better.

Our attention was suddenly attracted by the world of e-commerce, and we didn't hesitate to try a new approach in the medical sector by opening our website. It's been 10 years of work and the challenge continues to be more intense. The market is impervious to new perspectives and the sale of medical products must keep up with the times. Following the needs of final consumers and patients, we try to select the best options available on the market without forgetting what most distinguishes us: direct dialogue and human relationship. The relationship with customers is the most important thing we care about and try to keep alive in a digital and detached society.

ISO 9001:2015 | Quality products

It is a standard that defines the requirements of a quality management system, for the purpose of conducting company processes, following codified work procedures to ensure the constancy of production and management processes and to contribute to their continuous improvement, all aimed at ensuring customer satisfaction.

ISO 13485:2021 | Quality of medical devices

It is a standard that specifies the requirements for quality management systems that allow an organization to demonstrate its ability to provide medical devices and related services that comply with customer requirements and regulatory requirements applicable to such medical devices.

CE 0425 | Compliance in the EU market

It is a certificate that indicates compliance with all the obligations incumbent on manufacturers, distributors and importers regarding their products by virtue of EU Community standards, allowing the free marketing of marked products within the European market.

INDEX

GYNECOLOGY

- Disposable vaginal speculum pag. 5
- Disposable obstetrics pag. 6
- Cannulas for intrauterine aspiration pag. 10
- Modular kits for Sterile Pap-test pag. 11
- Pessaries for utero-vaginal prolapse pag. 12

PATIENT CARE

- Visit and protection pag. 13
- Long hospital stays pag. 16

ELECTROSURGERY

- Push-button handpieces pag. 19
- Pedal handpieces and accessories pag. 20
- Adapters for monopolar handpieces pag. 21
- Electrodes for handpieces pag. 22
- Disposable patient plates pag. 26
- Plate cables pag. 28
- Mono and bipolar electro-surgical forceps pag. 29
- Cables for electro-surgical forceps pag. 31

SURGICAL ASPIRATION

- Vases and accessories pag. 32
- Cannulas and tubes pag. 33

OXYGEN THERAPY

- Mask and goggles pag. 34

RESPIRATORY THERAPY

- Pep Mask pag. 37
- Pep Mask accessories pag. 38

OTOLARYNGOLOGY

- Tracheostomy cannulas pag. 39
- Cannula accessories pag. 43

ULTRASOUND

E.C.G. electrodes and gel

pag. 44

Gel for ultrasound

pag. 45

Sony paper and printers

pag. 46

Mitsubishi paper

pag. 49

ALPHABETICAL INDEX OF PRODUCTS

pag. 50

Disposable vaginal speculum | GYNECOLOGY

The speculum is a medical device that is used during the gynecological examination to keep the vaginal orifice open in order to carry out analyzes and operations.

CODE		DIAMETER	CND	RDM	BOX
0101	sterile	Ø 36 mm	U089006	1382682	120 pcs
0102	sterile	Ø 20 mm	U089006	1382682	120 pcs
0103	sterile	Ø 28 mm	U089006	1382682	120 pcs
0101/NS	non sterile	Ø 36 mm	U089006	2671748	150 pcs
0102/NS	non sterile	Ø 20 mm	U089006	2671748	150 pcs
0103/NS	non sterile	Ø 28 mm	U089006	2671748	150 pcs

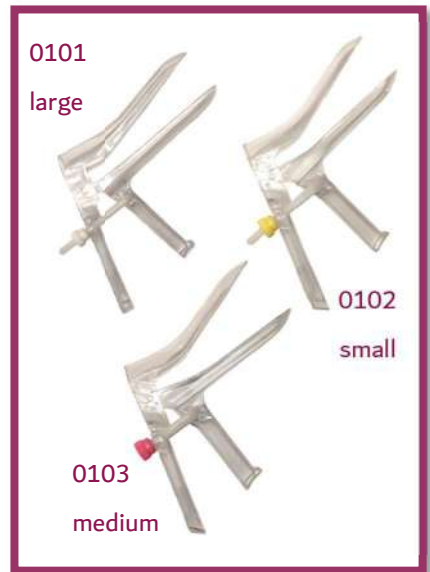

ADJUSTMENT MODEL

SIDE SCREW GRADUAL

CODE		DIAMETER	CND	RDM	BOX
0105	sterile	Ø 26 mm	U089006	1382682	150 pcs
0105/NS	sterile	Ø 26 mm	U089006	2671390	200 pcs



PIN MODEL

SERRATED CENTRAL

CODE		DIAMETER	CND	RDM	BOX
0104	sterile	Ø 20 mm	U089006	1382682	120 pcs
0104/S	sterile	Ø 24 mm	U089006	1382682	120 pcs
0105/S	sterile	Ø 26 mm	U089006	1382682	120 pcs
0106	sterile	Ø 30 mm	U089006	1382682	120 pcs
0104/NS	non sterile	Ø 20 mm	U089006	2671390	150 pcs
0104/SNS	non sterile	Ø 24 mm	U089006	2671390	150 pcs
0105/SNS	non sterile	Ø 26 mm	U089006	2671390	150 pcs
0106/NS	non sterile	Ø 30 mm	U089006	2671390	150 pcs

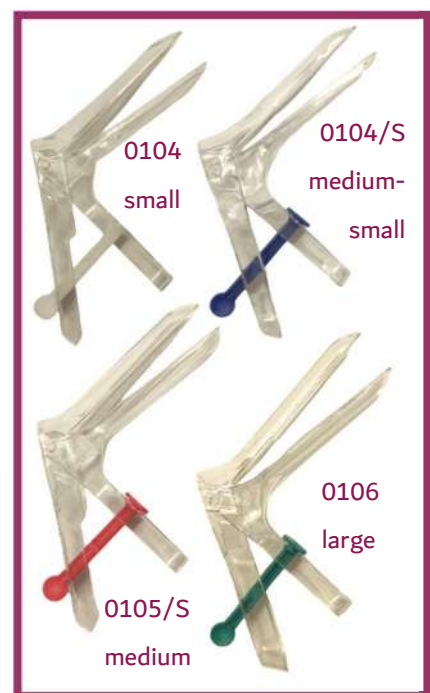

ADJUSTMENT MODEL

CENTRAL PIN

Disposable obstetrics | GYNECOLOGY

STERILE DISPOSABLE UMBILICAL CORD CLAMP

The clamps are used to close the umbilical cord before cutting it. The irreversible locking with side stops prevents the umbilical cord from coming out.



CODE		CLAMP LENGTH	CND	RDM	BOX
0111	sterile	3,2 mm	V0202	1382691	500 pcs
0111/L	sterile	3,6 mm	V0202	1382691	100 pcs

STERILE DISPOSABLE AMNIOTIC MEMBRANE PERFORATOR

The amniotic membrane perforator is used for the voluntary rupture of the amniotic membrane before childbirth.



CODE		LENGTH	CND	RDM	BOX
0120	sterile	26 cm	U089004	1382704	250 pcs
0120	sterile	26 cm	U089004	1382704	600 pcs

STERILE ENDOMETRIAL BIOPSY SET

An endometrial biopsy is a method of taking material from within the endometrium for diagnostic use in order to identify any abnormal cells and the effects that hormones have on the endometrium itself.



CODE		DIAMETER	CND	RDM	BOX
0130	sterile	Ø 4 mm	A010299	1382715	50 pcs
0131	sterile	Ø 2,5 mm	A010299	1382715	50 pcs

STERILE DISPOSABLE HYSTEROMETRIC DILATATION PROBE

The dilator hysteroetric probe is a device for temporary use to measure the depth of the uterus.



CODE		LENGTH	CND	RDM	BOX
0133	sterile	25 cm	U089003	1382740	250 pcs
0133	sterile	25 cm	U089003	1382740	500 pcs

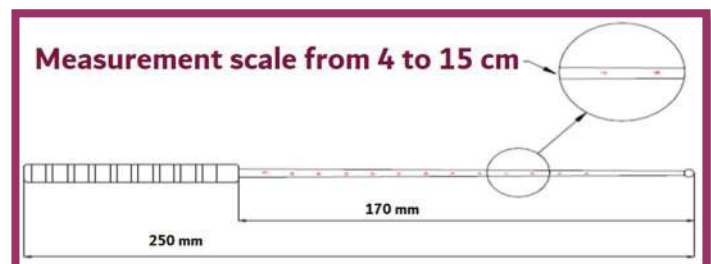

DISPOSABLE ENDOCERVICAL COLLECTION BRUSH

The endocervical collection brush is used to allow the sampling of endocervical cells for cytological examination.



CODE		LENGTH	CND	RDM	BOX
0134	sterile	192 mm	U09030301	1382767	250 pcs
0134	sterile	192 mm	U09030301	1382767	1.000 pcs
0134/NS	non sterile	192 mm	U09030301	2441284	Pack of 50 pcs Box of 5000 pcs

ENDOMETRIAL SAMPLING PROBE, "ENDOCYTE" TYPE, DISPOSABLE STERILE

The probe allows to collect cells present inside the vaginal cavity for the prevention of pathologies of the uterus neck.

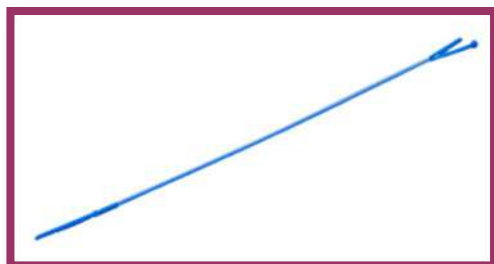

CODE		LENGTH	CND	RDM	BOX
0135	sterile	26 cm	A99	1382778	250 pcs
0135	sterile	26 cm	A99	1382778	500 pcs

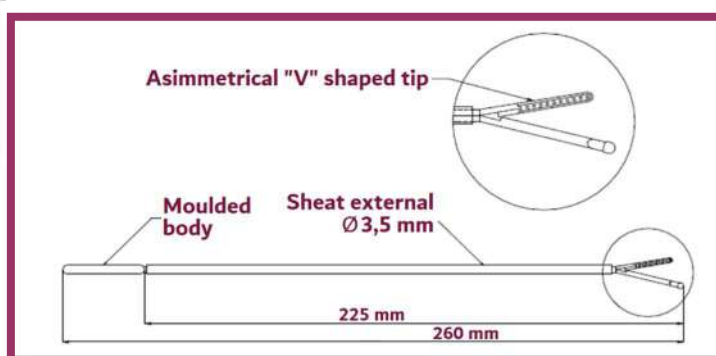

DISPOSABLE WOODEN AYRE SPATULAS

The Ayre spatula is used in the pap test by taking the ectocervix, inserting the longest part at the beginning of the cervical orifice and rotating the spatula 360 degrees clockwise.



CODE		LENGTH	CND	RDM	BOX
0136	sterile	18 cm	U0899	1382797	Pack of 500 pcs Box of 4.000 pcs
0136/NS	non sterile	18 cm	U0899	2441282	Pack of 100 pcs Box of 5.000 pcs

DISPOSABLE COTTON SWAB FOR SAMPLING

The swab is used to take samples of cells inside the vaginal cavity in a delicate and painless way.



CODE		LENGTH	CND	RDM	BOX
0137	sterile	153 mm	M010103	1382827	Pack of 500 pcs Box of 4.000 pcs
0137/NS	non sterile	153 mm	M010103	2470362	Pack of 100 pcs Box of 1.000 pcs

MINICONTAINER FOR NON STERILE SLIDES

The slide containers are a trasoirt accessory for slides, used for cytological samples and collected for inspection purposes.



CODE	DESCRIPTION	CND	RDM	BOX
0138	2 places minicontainer for slides mm. 26 x 76, vertical housing model	W0202050385	2441304	100 pcs
0138/P	2 places minicontainer for slides mm. 75 x 85, wallet model with snap closure	W0202050385	2441304	100 pcs

SPRAY CYTOLOGICAL FIXER

The fixer is indicated to fix the cellular material smeared on the slide ensuring the stability of the sample. It guarantees a perfect and long conservation of the biological material.

CODE		CAPACITY	CND	RDM	BOX
0139	non sterile	250 ml	W01030705	2441305	12 pcs



SLIDES FOR CYTOLOGY, GROUND AND WITH SANDBLASTED BAND

The slide is the basis for depositing the samples taken for diagnostic tests.



CODE		CND	RDM	BOX
0140	non sterile	W0503900201	2441247	Pack of 50 pcs Box of 2.500 pcs

NON-LUBRICATED LATEX PROBE COVER

The non-sterile ultrasound probe covers made of latex reduce the risk of infections, the size of the probe cover with a diameter of Ø 35 mm is suitable for vaginal probes.

CODE		SIZE	CND	RDM	BOX
KX07	non sterile	Ø 35 mm Length 191-199 mm	T030102	963672	500 pcs



LUBRICATED PROBE COVER ECLIPSE® - PARKER

A soft, disposable probe cover for medical ultrasound probes/transducers, pre-gelled inside with Aquasonic® 100 Ultrasound Transmission Gel. Fits most endocavity ultrasound probes.

CODE		SIZE	CND	RDM	BOX
38-01	non sterile	Lubricated Ø 60-44 mm Lenght 241 mm	T030102	125421	100 pcs



STERILE LUBRICANT GEL COGEL - COMEDICAL

Designed and manufactured to be used in association with other Medical Devices (e.g. endoscopes, bladder catheters, speculum, endotracheal tubes, nutritional tubes, etc.) used in diagnostic and therapeutic procedures. The gel can also be used in ultrasound scans and for the preparation of mixtures for diagnostic and therapeutic uses.

CODE		DESCRIPTION	CND	RDM	BOX
PAG09NA1Q	sterile	Pre-filled syringe with lubricating gel – 10 ml	A02010799	1263384	50 pcs



DISPOSABLE CERVICAL MATURATION BALLOON

The Cervical Maturation Balloon is a double balloon catheter made of silicone. The maximum inflation of the balloon is 80 ml/balloon and is used in natural birth induction procedures.

CODE		DESCRIPTION	TYPE	CND	RDM	BOX
43.03.10001	sterile	Double balloon catheter	Normal	U0899	2330422	10 pcs

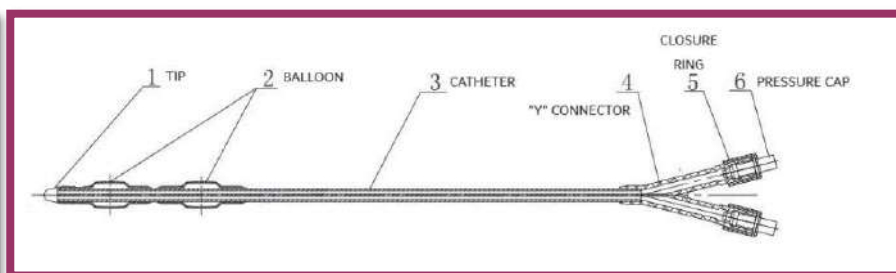

Cannulas for intrauterine aspiration | GYNECOLOGY

The intrauterine suction cannula is used for voluntary termination of pregnancy.



CODE		DIAMETER	CND	RDM	BOX
0150/6	sterile	Ø 6 mm	A06010103	1382858	100 pcs
0150/7	sterile	Ø 7 mm	A06010103	1382858	100 pcs
0150/8	sterile	Ø 8 mm	A06010103	1382858	100 pcs
0150/9	sterile	Ø 9 mm	A06010103	1382858	100 pcs
0150/10	sterile	Ø 10 mm	A06010103	1382858	100 pcs
0150/11	sterile	Ø 11 mm	A06010103	1382858	100 pcs
0150/12	sterile	Ø 12 mm	A06010103	1382858	100 pcs

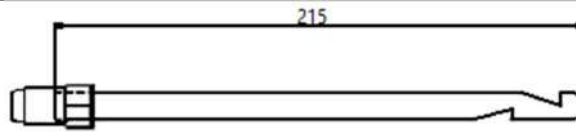

LENGTH CM. 18.5

CODE		DIAMETER	CND	RDM	BOX
0150/7-BR	sterile	Ø 7 mm	A06010103	1382848	100 pcs
0150/8-BR	sterile	Ø 8 mm	A06010103	1382848	100 pcs
0150/9-BR	sterile	Ø 9 mm	A06010103	1382848	100 pcs
0150/10-BR	sterile	Ø 10 mm	A06010103	1382848	100 pcs
0150/11-BR	sterile	Ø 11 mm	A06010103	1382848	100 pcs
0150/12-BR	sterile	Ø 12 mm	A06010103	1382848	100 pcs

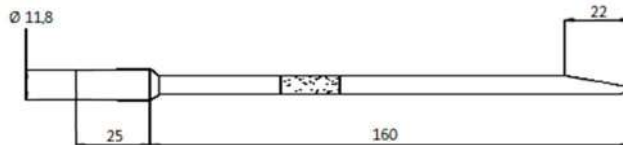

LENGTH CM. 18.5

CODE		DIAMETER	CND	RDM	BOX
0150/7-BC	sterile	Ø 7 mm	A06010103	1382848	100 pcs
0150/8-BC	sterile	Ø 8 mm	A06010103	1382848	100 pcs
0150/9-BC	sterile	Ø 9 mm	A06010103	1382848	100 pcs
0150/10-BC	sterile	Ø 10 mm	A06010103	1382848	100 pcs
0150/11-BC	sterile	Ø 11 mm	A06010103	1382848	100 pcs
0150/12-BC	sterile	Ø 12 mm	A06010103	1382848	100 pcs

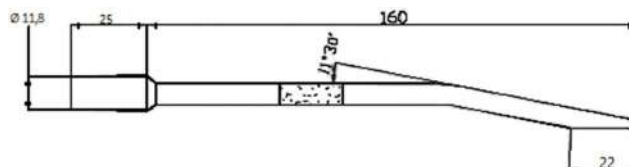

DISPOSABLE CANNULAS FOR INTRAUTERINE ASPIRATION "KARMAN" METHOD

DISPOSABLE CANNULAS FOR INTRAUTERINE ASPIRATION, RIGID STRAIGHT FLUTE BEAK,

DISPOSABLE CANNULAS FOR INTRAUTERINE ASPIRATION, RIGID CURVED, FLUTE BEAK

Modular kits for Sterile Pap-test | GYNECOLOGY

The Pap-test is a painless exam for detecting the presence of abnormal cells in the cervix. It allows early diagnosis of cervical pathologies. The functional configuration of the kit allows immediate operation, it may contain the following types of products:

- n. 1 Speculum with side screw or central pin in various sizes
- n. 1 Wooden Ayre Spatula
- n. 1 Cotton swab
- n. 1 Brush for endocervical sampling
- n. 1 or 2 Microscope slides
- n. 1 or 2 Latex gloves for exploration
- n. 1 Minicontainer for slides
- n. 1 Probe for "Endocyte" sampling
- n. 1 Sachet of 4 ml cytological fixer

Following there are some combinations of sterile kits (**CND: U0899** and **RDM: 1382628**) that can be modified or created on request (contact the sales office for a specific quotation):

CODE	SPECULUM	SPEC. SIZE	GLOVE	MINI CONTAINER	SLIDE	AYRE SPAT.	COTTON SWAB	BRUSH	ENDOCYTE PROBE	CYTOLOGICAL FIXER	KIT NR/ BOX
0161	Side screw	Large	1 pc	x		x	x				100 pz
0162	Side screw	Small	1 pc	x		x	x				100 pz
0163	Side screw	Medium				x	x				100 pz
0171	Side screw	Large			1 pc	x		x			100 pz
0172	Side screw	Small			1 pc	x		x			100 pz
0173	Side screw	Medium			1 pc	x		x			100 pz
0181	Central pin	Large		x	2 pcs	x	x	x			100 pz
0182	Central pin	Small		x	2 pcs	x	x	x			100 pz
0183	Central pin	Medium		x	2 pcs	x	x	x			100 pz
0185			1 pc	x	1 pc	x		x			100 pz
0191	Side screw	Large	1 pc	x	2 pcs	x	x		x		50 pz
0192	Side screw	Small	1 pc	x	2 pcs	x	x		x		50 pz
0193	Side screw	Medium	1 pc	x	2 pcs	x	x		x		50 pz
0194				x	1 pc	x		x			50 pz
0195	Central pin	Medium	2 pcs	x	2 pcs	x		x			100 pz
0196			2 pcs	x	2 pcs	x		x			100 pz
0198					1 pc	x		x		1 bustina	100 pz

Pessaries for utero-vaginal prolapse | GYNECOLOGY

The pessary is a rubber or silicone ring that is inserted into the vagina between the vaginal fornix and the pubic bone, with the aim of preventing the complete prolapse of the uterus.



CODE		DIAMETER	CND	RDM	PACKAGING
FOR.70.51650	non sterile	Ø 50 mm	U089005	1160079	1 pc
FOR.70.51655	non sterile	Ø 55 mm	U089005	1160080	1 pc
FOR.70.51660	non sterile	Ø 60 mm	U089005	1160081	1 pc
FOR.70.51663	non sterile	Ø 63 mm	U089005	1160082	1 pc
FOR.70.51665	non sterile	Ø 65 mm	U089005	1160084	1 pc
FOR.70.51670	non sterile	Ø 70 mm	U089005	1160099	1 pc
FOR.70.51675	non sterile	Ø 75 mm	U089005	1160102	1 pc
FOR.70.51680	non sterile	Ø 80 mm	U089005	1160109	1 pc
FOR.70.51683	non sterile	Ø 83 mm	U089005	1160110	1 pc
FOR.70.51685	non sterile	Ø 85 mm	U089005	1160111	1 pc
FOR.70.51689	non sterile	Ø 89 mm	U089005	1160112	1 pc
FOR.70.51690	non sterile	Ø 90 mm	U089005	1160114	1 pc
FOR.70.51695	non sterile	Ø 95 mm	U089005	1160115	1 pc
FOR.70.516100	non sterile	Ø 100 mm	U089005	1160117	1 pc

PESSARY

RUBBER



CODE		DIAMETER	CND	RDM	PACKAGING
FOR.70.51750	non sterile	Ø 50 mm	U089005	19867	1 pc
FOR.70.51755	non sterile	Ø 55 mm	U089005	1160127	1 pc
FOR.70.51760	non sterile	Ø 60 mm	U089005	1160128	1 pc
FOR.70.51765	non sterile	Ø 65 mm	U089005	1160129	1 pc
FOR.70.51770	non sterile	Ø 70 mm	U089005	1160130	1 pc
FOR.70.51775	non sterile	Ø 75 mm	U089005	1160131	1 pc
FOR.70.51780	non sterile	Ø 80 mm	U089005	1160132	1 pc
FOR.70.51785	non sterile	Ø 85 mm	U089005	1160133	1 pc
FOR.70.51790	non sterile	Ø 90 mm	U089005	1160134	1 pc
FOR.70.51795	non sterile	Ø 95 mm	U089005	1160135	1 pc
FOR.70.517100	non sterile	Ø 100 mm	U089005	1160136	1 pc

PESSARY

SILICONE



CODE		DIAMETER	CND	RDM	PACKAGING
FOR.70.51950	sterile	Ø 50 mm	U089005	1295458	1 pc
FOR.70.51955	sterile	Ø 55 mm	U089005	1295786	1 pc
FOR.70.51960	sterile	Ø 60 mm	U089005	1295789	1 pc
FOR.70.51965	sterile	Ø 65 mm	U089005	1295791	1 pc
FOR.70.51970	sterile	Ø 70 mm	U089005	1295793	1 pc
FOR.70.51975	sterile	Ø 75 mm	U089005	1295794	1 pc
FOR.70.51980	sterile	Ø 80 mm	U089005	1295796	1 pc
FOR.70.51985	sterile	Ø 85 mm	U089005	1295797	1 pc
FOR.70.51990	sterile	Ø 90 mm	U089005	1295799	1 pc
FOR.70.51995	sterile	Ø 95 mm	U089005	1295801	1 pc
FOR.70.519100	sterile	Ø 100 mm	U089005	1295802	1 pc

SILICONE PESSARY

STERILE BLUE

Visit and protection | PATIENT CARE

The right equipment is essential to support medical staff during visits to avoid infecting open tissues and to assist the patient during hospitalization.

DISPOSABLE WOODEN TONGUE DEPRESSOR

It allows the mechanical flattening of the tongue against the oral floor in order to improve the vision of the pharynx, larynx and oral cavity.



CODE		DESCRIPTION	CND	RDM	BOX
AB-0136	sterile	wooden depressor 15,2 cm	V9001	1382892	Pack of 500 pcs Box of 4.000 pcs
AB-0136	sterile	wooden depressor 15,2 cm	V9001	1382892	Pack of 200 pcs Box of 4.000 pcs
AB-0136/NS	non sterile	wooden depressor 15,2 cm	V9001	2441281	Pack of 100 pcs Box of 5.000 pcs
AB-0136/P	sterile	plastic depressor 14,6 cm	V9001	1382892	500 pcs

STERILE LATEX GLOVES FOR MEDICATION AND EXPLORATION

Latex gloves are produced with rubber latex, a material of natural origin from the rubber tree.

THE SINGLE PACK CONSISTS OF 2 LATEX GLOVES



CODE		SIZE	CND	RDM	BOX
0180/LM2	sterile	Medium	T010201	1382871	100 pairs
0180/LL2	sterile	Large	T010201	1382871	100 pairs

CODE	SIZE	PALM WIDTH	MIN LENGTH
0180/LM2	M/7-7,5	85-105 mm	240 mm
0180/LL2	L/8-8,5	100-120 mm	240 mm

STERILE DISPOSABLE TWEEZERS FOR MEDICATION

Medical device necessary for the removal of small foreign bodies and indirect medication.

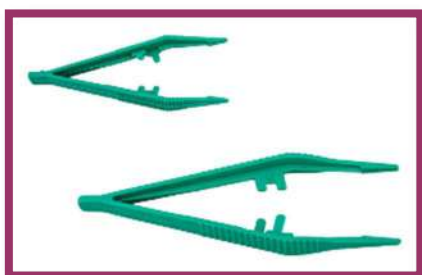

CODE		SIZE	CND	RDM	BOX
PIN 102	sterile	13 cm	V9099	1383093	100 pcs
PIN 103	sterile	8 cm	V9099	1383093	300 pcs

DISPOSABLE ANOSCOPE

Anoscopy is always preceded by a visual examination of the anal opening and manual exploration by the doctor. After careful lubrication, the anoscope is then inserted into the anal canal slowly and delicately.



CODE		SIZE	CND	RDM	BOX
0601	sterile	length 10 cm tube Ø 20 mm spindle Ø 15 mm	G02060301	1382877	60 pz

DECONTAMINANT MATS WITH BIT BACTERIOSTATIC AGENTS

Composed of 30 blue sheets, numbered from n.1 to n.30. Adhesive backing on floor side surface totally removable. A decontaminating carpet works through a bactericidal jelly which removes bacteria from the soles of the shoes.



CODE		SIZE	CND	RDM	BOX
TAP 11545	non sterile	115x45 cm	T030501	2630140	8 mats
TAP 11560	non sterile	115x60 cm	T030501	2630140	8 mats
TAP 11590	non sterile	115x90 cm	T030501	2630140	8 mats

SHOE COVERS

Non-slip shoe covers are designed to prevent falls and slips. Made with rubber soles or grippy materials, they ensure stability and safety on slippery or wet floors.

CODE		DESCRIPTION	SIZE	TYPE	CND	RDM	BOX
21094	non sterile	Lightweight PP shoe cover with elastic band	15x40 cm	Normal	T0208	2624240	2.000 pcs
21095	non sterile	Lightweight PP shoe cover, with elastic band and print on the sole	15x40 cm	Non-slip	T0208	2624240	1.000 pcs



COT ROLL IN PURE CELLULOSE 2 PLY - LUCART

The Lucart Professional brand embossed pure cellulose roll offers comfort and resistance during exams or treatments, guaranteeing hygiene and practicality.

CODE	DESCRIPTION	CERTIFICATE	HEIGHT	LENGTH	WEIGHT	BOX
870099	ECONATURAL Cot roll with bacteriostatic lotion col. Havana, tear 37 cm	ECOLABEL* + FSC Recycled**	59 cm	70 m	34 gr/m ²	6 pcs
870072J	STRONG80 Cot roll with bacteriostatic lotion col. White, tear 37 cm	ECOLABEL* + PEFC***	59 cm	80 m	34 gr/m ²	6 pcs
870074U	ECO80 Cot roll with bacteriostatic lotion col. White, tear 37 cm	ECOLABEL*	59 cm	80 m	35 gr/m ²	6 pcs
870090J	EASY80 GREEN Cot roll with bacteriostatic lotion col. Green, tear 37 cm	ECOLABEL*	59 cm	80 m	35 gr/m ²	6 pcs



***EU Ecolabel** Certified is the European Union's ecological quality mark that distinguishes products and services which, while guaranteeing high performance standards, are characterized by a reduced environmental impact during the entire life cycle.

****FSC Recycled** Certified means that 100% of the paper fiber is recycled and at least 85% of the material comes from post-consumer waste.

*****PEFC** Certified for Sustainable Forest Management ensures that forests are managed in line with stringent environmental, social and economic requirements. Chain of custody certification tracks forest products from sustainably managed forests to the final product.

Long hospital stays | PATIENT CARE

RIGID PLASTIC HOLDER FOR IV

It has a universal size, it's shockproof and it's equipped with a closed ring quick coupling system. It engages on the stand and adapts to glass bottles, medicines or bags for infusion therapies.



CODE		SIZE	CND	RDM	BOX
1001	non sterile	ø 96 mm – height 285 mm	V0899	2558987	40 pcs

INSTANT ICE IN BAGS

Thanks to its pain-relieving, anti-edema and muscle relaxant effects, instant ice is specifically indicated in case of musculoskeletal trauma, bruises, sprains.



CODE		DESCRIPTION	CND	RDM	BOX
04-YETI	non sterile	Instant ice in TNT bag 13,5x16,5 cm	M9001	2651738	24 pcs
05-YETI	non sterile	Instant ice in PE bag 13,5x16,5 cm	M9001	2651344	24 pcs

DISPOSABLE WASHING MITTEN/SPONGE FOR PATIENT

Provides effective hygiene in a comfortable and safe way for the patient.



CODE	DESCRIPTION	SIZE	CND	RDM	PACKAGING
700708*	Soaped MITTEN in TNT	23x16 cm	N.A.	N.A.	Bags of 50 pcs Box of 20 bags
700703	Unsoaped MITTEN in TNT	23x16 cm	N.A.	N.A.	Bags of 50 pcs Box of 20 bags
700878**	Soaped SPONGE	125x80x20 mm	N.A.	N.A.	120 pcs
700873	Unsoaped SPONGE	125x80x20 mm	N.A.	N.A.	120 pcs



*The product is registered as COSMETIC in the CPNP with the nr. 2083323 – Disposable TNT Molton mitten, pre-soaped with isocutaneous neutral Ph detergent

**The product is registered as COSMETIC in the CPNP with the nr. 1644125 - Disposable sponge in biocompatible polyurethane foam, pre-soaped with isocutaneous neutral Ph detergent

DIAPERS SOFFISOF AIR DRY

The diapers are designed for patients forced to stay in bed and for subjects with pathologies that lead to incontinence.

CODE	DESCRIPTION	SIZE	ABSORBENCE	WAISTLINE	CND	RDM	BOX
36710	Diapers Air Dry - A mutandina (panties)	M	Maxi	70-110 cm	T04010103	2414424	60 pcs
36715	Diapers Air Dry - Pants	M	Extra	70-110 cm	T04010103	2345252	84 pcs



Push-button handpieces Valleylab 3 PIN socket | ELECTROSURGERY

Device to be used for CUT and COAG (coagulation) of tissues, during the electrosurgical procedure.

CODE		ELECTRODE	CABLE LENGTH	CND	RDM	BOX
0201/C+0210-7	sterile	blade 7 cm	3 mt	K0201010501	12947	100 pcs
0201/C+0220-7	sterile	needle 7 cm	3 mt	K0201010501	12947	100 pcs
0201/C+0210-15	sterile	blade 15 cm	3 mt	K0201010501	12947	100 pcs
0201/C5+0210-7	sterile	blade 7 cm	5 mt	K0201010501	12947	75 pcs



Tasti CUG-COAG



Preso tipo Valleylab

Combined kit of handpiece and abrasive sponge code 0203 or holster.

CODE		KIT	CABLE LENGTH	CND	RDM	BOX
0201/KITS	sterile	0201/KITS + 0203	3 mt	K0299	12969	100 pcs
0201/KITS-5	sterile	0201/KITS-5 + 0203	5 mt	K0299	12969	75 pcs
0201/KITH	sterile	0201/KITH + holster	3 mt	K0299	12969	100 pcs
0201/KITH-5	sterile	0201/KITH-5 + holster	5 mt	K0299	12969	75 pcs



The reusable handpiece can be subjected to multiple sterilization cycles and are supplied with a removable blade electrode in an anti-rotation hexagonal electrode coupling, compatible with all Ø 2.35 mm electrodes.

CODE		ELECTRODE	CABLE LENGTH	CND	RDM	PACK.
0201/CR+0210*	non sterile	blade 7 cm	3 mt	L180301	1687007	5 pcs
0201/CR5+0210*	non sterile	blade 7 cm	5 mt	L180301	1687057	5 pcs

*reusable 100 cycles



DISPOSABLE HANDPIECE
WITH CUT-COAG SWITCH

KIT WITH DISPOSABLE HANDPIECE WITH
CUT-COAG SWITCH

REUSABLE HANDPIECE WITH
CUT-COAG SWITCH

Pedal handpieces and accessories | ELECTROSURGERY

DISPOSABLE MONOPOLAR FOOT-PEDAL HANDPIECE WITH 4 MM DIAMETER PIN

The energy generated by the equipment passes continuously from the monopolar handpiece to the neutral plate through the tissue of the area being treated.



CODE		ELECTRODE	CABLE LENGTH	CND	RDM	PACKAGING
0202+0210-7	sterile	blade 7 cm	3 mt	K0201010501	12951	100 pcs
0202+0220-7	sterile	needle 7 cm	3 mt	K0201010501	12951	100 pcs
0202+0234-6	sterile	ball Ø 4 mm	3 mt	K0201010501	12951	100 pcs



REUSABLE MONOPOLAR HANDPIECE 30 CYCLES, FOOT-PEDAL WITH 4 MM DIAMETER PIN

Il manipo è un accessorio riutilizzabile e richiede pulizia e sterilizzazione prima di ciascun intervento sul paziente.

Le punte sono esclusivamente monouso e devono essere smaltite a norma di legge dopo uso sul paziente.



CODE		ELECTRODE	CABLE LENGTH	CND	RDM	PACKAGING
0202R+0210-7	non sterile	blade 7 cm	3 mt	K020199	1035847	5 pcs
0202R5+0210-7	non sterile	blade 7 cm	5 mt	K020199	1035847	5 pcs



DISPOSABLE STERILE ABRASIVE SPONGE

The abrasive sponge helps in the rapid removal of coagulated material from the electrosurgical blades.



CODE		SIZE	CND	RDM	BOX
0203	sterile	50 x 50 mm	V07	1383086	500 pcs

DISPOSABLE STERILE DERMOGRAPHIC PEN WITH REGULAR POINT WITH RULER

Used for marking in general surgery, radiotherapy and position identification for B-type ultrasonography, medical education and other marking tasks.



CODE		SIZE	CND	RDM	PACKAGING
65-201-RQ-01	sterile	13 cm (cap closed)	V9004	2676801	100 pcs

Adapters for electrosurgical knife | ELECTROSURGERY

The adapters are used on handpieces with manual activation with a standard Ø 4 mm 3-pin Valleylab type connection.

CODE		DESCRIPTION	CND	RDM	PACKAGING
0503 (F4833)	reusable	Erbe series T Ø 4 mm	Z12010980	2223460	1 pc
0503/ICC (F4832)	reusable	Erbe series ICC and ACC connector Ø 5mm.	Z12010980	2223459	1 pc
0504 (F4831)	reusable	Martin / Berchtold	Z12010980	2223458	1 pc



Electrodes for handpieces | ELECTROSURGERY

ELECTRODES FOR HANDPIECES – STANDARD STEEL

The electrodes are inserted into the handpieces, each surgical operation requires one of the available shapes: blade, needle and ball.

CODE		SIZE	CND	RDM	PACKAGING
0210-7	sterile	blade cm. 7	K0201010301	2627683	25 pcs
0210-7P	sterile	bent blade cm. 7	K0201010301	2627683	25 pcs
0210-10	sterile	blade cm. 10	K0201010301	2627683	25 pcs
0210-15	sterile	blade cm. 13	K0201010301	2627683	25 pcs
0220-7	sterile	needle cm. 7	K0201010301	2627683	25 pcs
0220-7P	sterile	bent needle cm. 7	K0201010301	2627683	25 pcs
0220-13	sterile	needle cm. 13	K0201010301	2627683	25 pcs
0232-6	sterile	ball Ø 2 mm./length 6 cm.	K0201010301	2627683	25 pcs
0232-6P	sterile	bent ball Ø 2 mm./ length 6 cm.	K0201010301	2627683	25 pcs
0233-13	sterile	ball Ø 3 mm./ length 13 cm.	K0201010301	2627683	25 pcs
0234-6	sterile	ball Ø 4 mm./ length 6 cm.	K0201010301	2627683	25 pcs
0234-6P	sterile	bent ball Ø 4 mm./ length 6 cm.	K0201010301	2627683	25 pcs
0234-13	sterile	ball Ø 4 mm./ length 13 cm.	K0201010301	2627683	25 pcs
0235-6	sterile	ball Ø 5 mm./ length 6 cm.	K0201010301	2627683	25 pcs
0235-6P	sterile	bent ball Ø 5 mm./ length 6 cm.	K0201010301	2627683	25 pcs
0235-13	sterile	ball Ø 5 mm./ length 13 cm.	K0201010301	2627683	25 pcs

N.B.: if indicated sterile, the product is disposable

CODE		SIZE	CND	RDM	PACKAGING
R-0210-7	reusable	blade cm. 7	L1299	12558	10 pcs
R-0210-7P	reusable	bent blade cm. 7	L1299	12558	10 pcs
R-0210-10	reusable	blade cm. 10	L1299	12558	10 pcs
R-0210-15	reusable	blade cm. 15	L1299	12558	10 pcs
R-0220-7	reusable	needle cm. 7	L1299	12558	10 pcs
R-0220-7P	reusable	bent needle cm. 7	L1299	12558	10 pcs
R-0220-13	reusable	needle cm. 13	L1299	12558	10 pcs
R-0221-5	reusable	fine needle cm. 5	L1299	12558	10 pcs
R-0232-6	reusable	ball Ø 2 mm./ length 6 cm.	L1299	12558	10 pcs
R-0232-6P	reusable	bent ball Ø 2 mm./ length 6 cm.	L1299	12558	10 pcs
R-0233-13	reusable	ball Ø 3 mm./ length 13 cm.	L1299	12558	10 pcs
R-0234-6	reusable	ball Ø 4 mm./ length 6 cm.	L1299	12558	10 pcs
R-0234-6P	reusable	bent ball Ø 4 mm./ length 6 cm.	L1299	12558	10 pcs
R-0234-13	reusable	ball Ø 4 mm./ length 13 cm.	L1299	12558	10 pcs
R-0235-6	reusable	ball Ø 5 mm./ length 6 cm.	L1299	12558	10 pcs
R-0235-6P	reusable	bent ball Ø 5 mm./ length 6 cm.	L1299	12558	10 pcs
R-0235-13	reusable	ball Ø 5 mm./ length 13 cm.	L1299	12558	10 pcs

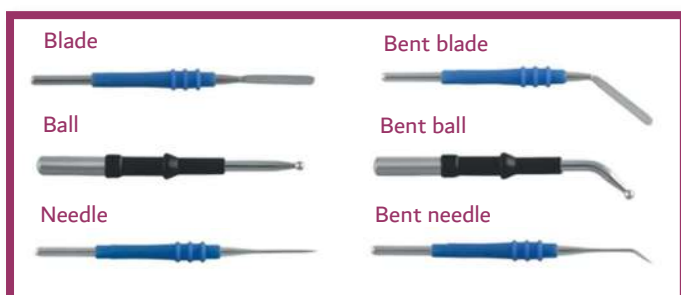

SEMI-ROUND LOOP - LENGTH CM. 13

Loop electrodes coding method:

The first group of numbers indicate the shape of the electrode as follows: **0250 = Semicircular loop**

In the second group of numbers the first two digits indicate in mm. **the height (A)** and the second two **the width (B)**

The last two digits indicate **the total length (L)** of the electrode stem (-13= cm 13)

CODE		SIZE		CND	RDM	PACKAGING
0250-1005-13	sterile	cm. 1,0 x 0,5	semi-round loop	K0201010301	2627683	25 pcs
0250-1007-13	sterile	cm. 1,0 x 0,7	semi-round loop	K0201010301	2627683	25 pcs
0250-1008-13	sterile	cm. 1,0 x 0,8	semi-round loop	K0201010301	2627683	25 pcs
0250-1010-13	sterile	cm. 1,0 x 1,0	semi-round loop	K0201010301	2627683	25 pcs
0250-1015-13	sterile	cm. 1,0 x 1,5	semi-round loop	K0201010301	2627683	25 pcs
0250-1505-13	sterile	cm. 1,5 x 0,5	semi-round loop	K0201010301	2627683	25 pcs
0250-1507-13	sterile	cm. 1,5 x 0,7	semi-round loop	K0201010301	2627683	25 pcs
0250-1508-13	sterile	cm. 1,5 x 0,8	semi-round loop	K0201010301	2627683	25 pcs
0250-1510-13	sterile	cm. 1,5 x 1,0	semi-round loop	K0201010301	2627683	25 pcs
0250-1512-13	sterile	cm. 1,5 x 1,2	semi-round loop	K0201010301	2627683	25 pcs
0250-1515-13	sterile	cm. 1,5 x 1,5	semi-round loop	K0201010301	2627683	25 pcs
0250-2008-13	sterile	cm. 2,00 x 0,8	semi-round loop	K0201010301	2627683	25 pcs
0250-2010-13	sterile	cm. 2,00 x 1,0	semi-round loop	K0201010301	2627683	25 pcs
0250-2012-13	sterile	cm. 2,00 x 1,2	semi-round loop	K0201010301	2627683	25 pcs
0250-2015-13	sterile	cm. 2,00 x 1,5	semi-round loop	K0201010301	2627683	25 pcs
0250-2020-13	sterile	cm. 2,00 x 2,00	semi-round loop	K0201010301	2627683	25 pcs

N.B.: if indicated sterile, the product is disposable

CODE		SIZE		CND	RDM	PACKAGING
R 0250-1005-13	reusable	cm. 1,0 x 0,5	semi-round loop	L12991	12558	5 pcs
R 0250-1007-13	reusable	cm. 1,0 x 0,7	semi-round loop	L12991	12558	5 pcs
R 0250-1008-13	reusable	cm. 1,0 x 0,8	semi-round loop	L12991	12558	5 pcs
R 0250-1010-13	reusable	cm. 1,0 x 1,0	semi-round loop	L12991	12558	5 pcs
R 0250-1015-13	reusable	cm. 1,0 x 1,5	semi-round loop	L12991	12558	5 pcs
R 0250-1505-13	reusable	cm. 1,5 x 0,5	semi-round loop	L12991	12558	5 pcs
R 0250-1507-13	reusable	cm. 1,5 x 0,7	semi-round loop	L12991	12558	5 pcs
R 0250-1508-13	reusable	cm. 1,5 x 0,8	semi-round loop	L12991	12558	5 pcs
R 0250-1510-13	reusable	cm. 1,5 x 1,0	semi-round loop	L12991	12558	5 pcs
R 0250-1512-13	reusable	cm. 1,5 x 1,2	semi-round loop	L12991	12558	5 pcs
R 0250-1515-13	reusable	cm. 1,5 x 1,5	semi-round loop	L12991	12558	5 pcs
R 0250-2008-13	reusable	cm. 2,00 x 0,8	semi-round loop	L12991	12558	5 pcs
R 0250-2010-13	reusable	cm. 2,00 x 1,0	semi-round loop	L12991	12558	5 pcs
R 0250-2012-13	reusable	cm. 2,00 x 1,2	semi-round loop	L12991	12558	5 pcs
R 0250-2015-13	reusable	cm. 2,00 x 1,5	semi-round loop	L12991	12558	5 pcs
R 0250-2020-13	reusable	cm. 2,00 x 2,00	semi-round loop	L12991	12558	5 pcs

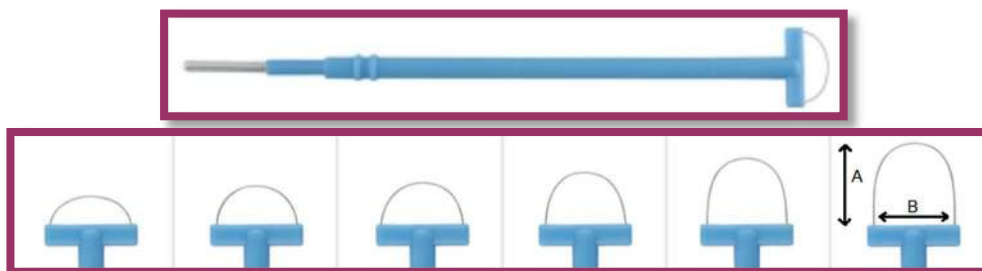

ROUND OR DIAMOND LOOP

The electrodes are used to operate on sections of tissue inside the body and the different shapes allow for a larger range of sections.

CODE		SIZE	CND	RDM	PACKAGING
0240-4-5	sterile	Ø 4 mm.- length cm 5 round loop	K0201010301	2627683	25 pcs
0240-8-5	sterile	Ø 8 mm.- length cm 5 round loop	K0201010301	2627683	25 pcs
0240-11-5	sterile	Ø 11 mm.- length cm 5 round loop	K0201010301	2627683	25 pcs
0240-D-5	sterile	length cm. 5 diamond loop	K0201010301	2627683	25 pcs

N.B.: if indicated sterile, the product is disposable

CODE		SIZE	CND	RDM	PACKAGING
R 0240-4-5	reusable	Ø 4 mm.- length cm 5 round loop	L12991	12558	5 pcs
R 0240-8-5	reusable	Ø 8 mm.- length cm 5 round loop	L12991	12558	5 pcs
R 0240-11-5	reusable	Ø 11 mm.- length cm 5 round loop	L12991	12558	5 pcs
R 0240-D-5	reusable	length cm. 5 diamond loop	L12991	12558	5 pcs



SQUARE LOOP AND SAIL FOR CONIZATION - LENGTH CM. 13

The electrodes are used on sections of tissue inside the body and the different shapes allow for a larger range of sections.

CODE		SIZE	CND	RDM	PACKAGING
0260-1004-13	sterile	cm. 1,0 x 0,4 square loop	K0201010301	2627683	25 pcs
0260-1005-13	sterile	cm. 1,0 x 0,5 square loop	K0201010301	2627683	25 pcs
0260-1007-13	sterile	cm. 1,0 x 0,7 square loop	K0201010301	2627683	25 pcs
0260-1008-13	sterile	cm. 1,0 x 0,8 square loop	K0201010301	2627683	25 pcs
0260-1010-13	sterile	cm. 1,0 x 1,0 square loop	K0201010301	2627683	25 pcs
0260-1015-13	sterile	cm. 1,0 x 1,5 square loop	K0201010301	2627683	25 pcs
0260-13	sterile	sail loop for conization	K0201010301	2627683	25 pcs

N.B.: if indicated sterile, the product is disposable

CODE		SIZE	CND	RDM	PACKAGING
R 0260-1004-13	reusable	cm. 1,0 x 0,4 square loop	L12991	12558	5 pcs
R 0260-1005-13	reusable	cm. 1,0 x 0,5 square loop	L12991	12558	5 pcs
R 0260-1007-13	reusable	cm. 1,0 x 0,7 square loop	L12991	12558	5 pcs
R 0260-1008-13	reusable	cm. 1,0 x 0,8 square loop	L12991	12558	5 pcs
R 0260-1010-13	reusable	cm. 1,0 x 1,0 square loop	L12991	12558	5 pcs
R 0260-1015-13	reusable	cm. 1,0 x 1,5 square loop	L12991	12558	5 pcs
R 0260-13	reusable	sail loop for conization	L12991	12558	5 pcs

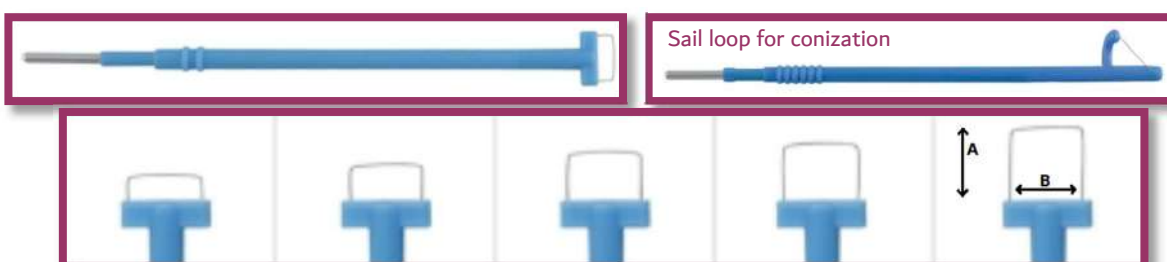

ELECTRODES FOR HANDPIECES - TUNGSTEN TIP

They are used in microscopic surgery and high-precision coagulation procedures. Their high heat resistance makes them ideal for applications requiring control and precision in biological tissues.

CODE		SIZE	CND	RDM	PACKAGING
170-120-05	sterile	protected needle 5 cm	K02030101	2621002	10 pcs
170-120-06	sterile	protected needle 6 cm	K02030101	2621002	10 pcs
170-120-07	sterile	protected needle 7 cm	K02030101	2621002	10 pcs
170-120-09	sterile	protected needle 9 cm	K02030101	2621002	10 pcs
170-120-12	sterile	protected needle 12 cm	K02030101	2621002	10 pcs
170-120-15	sterile	protected needle 15 cm	K02030101	2621002	10 pcs
170-122-05	sterile	bent protected needle 5 cm	K02030101	2621002	10 pcs
170-122-06	sterile	bent protected needle 6 cm	K02030101	2621002	10 pcs
170-122-07	sterile	bent protected needle 7 cm	K02030101	2621002	10 pcs
170-122-09	sterile	bent protected needle 9 cm	K02030101	2621002	10 pcs
170-122-12	sterile	bent protected needle 12 cm	K02030101	2621002	10 pcs
170-122-15	sterile	bent protected needle 15 cm	K02030101	2621002	10 pcs

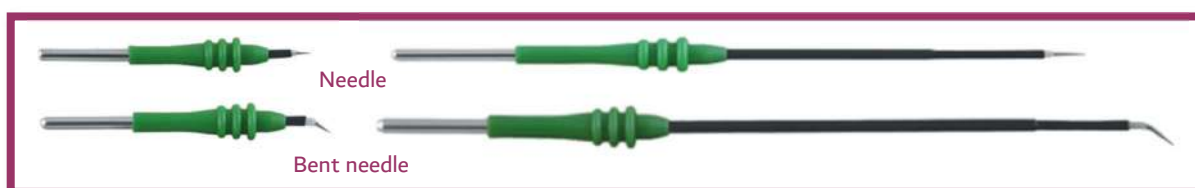

ELECTRODES FOR HANDPIECES - NON-STICK WITH TEFLON COATING

They are electrodes coated in PTFE, a material known for its high chemical resistance and low adhesion to tissues. These electrodes allow precise and safe medical procedures.

CODE		SIZE	CND	RDM	PACKAGING
150-110-06-NS	sterile	blade 6 cm	K0201010301	2621003	10 pcs
150-110-07-NS	sterile	blade 7 cm	K0201010301	2621003	10 pcs
150-110-10-NS	sterile	blade 10 cm	K0201010301	2621003	10 pcs
150-110-16-NS	sterile	blade 16 cm	K0201010301	2621003	10 pcs
151-110-06-NS	sterile	protected blade 6 cm	K0201010301	2621003	10 pcs
151-110-07-NS	sterile	protected blade 7 cm	K0201010301	2621003	10 pcs
151-110-10-NS	sterile	protected blade 10 cm	K0201010301	2621003	10 pcs
151-110-16-NS	sterile	protected blade 16 cm	K0201010301	2621003	10 pcs
150-120-07-NS	sterile	needle 7 cm	K0201010301	2621003	10 pcs
150-120-10-NS	sterile	needle 10 cm	K0201010301	2621003	10 pcs
150-120-15-NS	sterile	needle 15 cm	K0201010301	2621003	10 pcs
151-120-07-NS	sterile	protected needle 7 cm	K0201010301	2621003	10 pcs
151-120-10-NS	sterile	protected needle 10 cm	K0201010301	2621003	10 pcs
151-120-15-NS	sterile	protected needle 15 cm	K0201010301	2621003	10 pcs
151-160-05-NS	sterile	protected ball 5 cm	K0201010301	2621003	10 pcs
151-160-13-NS	sterile	protected ball 13 cm	K0201010301	2621003	10 pcs

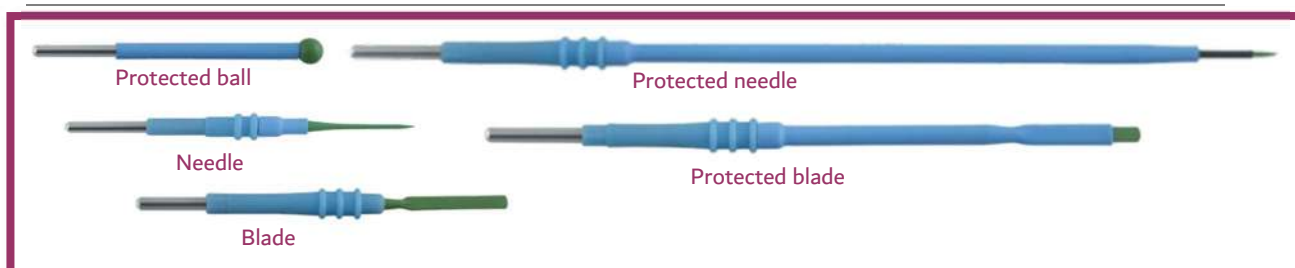

Disposable patient plates | ELECTROSURGERY

The correct positioning of the "patient plate" is extremely important in electrosurgery as it allows the correct passage of the current through the patient's body.

CODE	SIZE	TOTAL SURFACE	CONTACT SURFACE	CND	RDM	BOX
0350/C	non sterile cordless adult	217 cm ²	136 cm ²	K02010201	1217407	100 pcs
0351/C	non sterile cordless pediatric	145 cm ²	83 cm ²	K02010201	1217407	100 pcs
0352/C	non sterile cordless neonate	83 cm ²	32 cm ²	K02010201	1217407	50 pcs
0350/CS	non sterile adult with 3 mt cable	217 cm ²	136 cm ²	K02010201	1217407	50 pcs



0350/C



0351/C



0352/C



0350/CS

REM or two-part (aka Return Electrode Monitoring) electrosurgical plates for electrosurgical units are neutral electrodes to be used with electrosurgical units capable of controlling the correct contact of the plate with the patient's body.

CODE	SIZE	TOTAL SURFACE	CONTACT SURFACE	CND	RDM	BOX
0350/R	non sterile cordless adult	217 cm ²	128 cm ²	K02010202	1217419	100 pcs
0351/R	non sterile cordless pediatric	145 cm ²	73 cm ²	K02010202	1217419	100 pcs
0352/R	non sterile cordless neonate	83 cm ²	31 cm ²	K02010202	1217419	50 pcs
0350/RS	non sterile adult with 3 mt cable	217 cm ²	128 cm ²	K02010202	1217419	50 pcs
0350/RS-5	non sterile adult with 5 mt cable	217 cm ²	128 cm ²	K02010202	1217419	50 pcs
0351/RS	non sterile pediatric with 3 mt cable	145 cm ²	73 cm ²	K02010202	1217419	50 pcs
0352/RS	non sterile neonate with 3 mt cable	83 cm ²	31 cm ²	K02010202	1217419	50 pcs



0350/R



0351/R



0352/R



0350/RS



Connector 0350/RS
0351/RS and 0352/RS

ADHESIVE PRE-GELLED WITH HYDROGEL

SINGLE-PART DISPOSABLE PATIENT PLATE

ADHESIVE PRE-GELLED WITH HYDROGEL

TWO-PART DISPOSABLE PATIENT PLATE

The universal size plate allows you to cover a wider variety of patients, from newborns over 5 kg to adults.

CODE		SIZE	TOTAL SURFACE	CONTACT SURFACE	CND	RDM	BOX
2900	non sterile	universal	168 cm ²	105 cm ²	K020102	227565	100 pcs
2900-C/00	non sterile	universal w/3 mt. cable, Erbe connection	168 cm ²	105 cm ²	K020102	227508	50 pcs
2900-C/12	non sterile	universal w/3 mt. cable, Valleylab connection	168 cm ²	105 cm ²	K020102	227508	50 pcs



2900



2900-C/00



2900-C/12

UNIVERSAL PREGELLED ADHESIVE
 TWO-PART DISPOSABLE PATIENT PLATE

Plate cables | ELECTROSURGERY

REUSABLE CABLES FOR PATIENT PLATE USE

The paddle is a return or leakage electrode that collects the low-density current emitted to the electrosurgical unit by closing the circuit through the patient.

CODE	ELECTROSURGICAL KNIFE BRAND	MODELS	CABLE LENGTH	CND	RDM	PACK.	
030/AL01	non sterile	AESCULAP	TM- TM401	5 mt	Z12010980	2224048	1 pc
		ALEXANDRA	MOD. D205; E 300; 500D;102/201; 2020/E, 202, MICRO 180	universal			
		ALSA	All: MF100, MF360/A360,380,100,180.	attack			
		BERCHTOLD	ELEKTROTOM; 200; 390; 400; 540.	mono jacks			
		BIRCHTER	772; 773; 737; 737 XL; 774	Ø 6,3 mm			
		BOVIE	BOVIE CSV; URO; BS; 400/400;400SR; X10; X10L				
		BURDICK	U-7; SU-8				
		CAMERON-MILLER	26-1290				
		COBE	TS-403				
		CONCEPT	9600; 9700; 9800; 9900				
		DOLLEY	COBII 203 T; 502; 503T; 505T				
		EMS DAVOLI	SYSTEM 2000; 5000				
		ERBE	ACC / ICC				
		FASET	Series COBI				
		I CUATRO	MEGERI 1				
		LAMIDEY	SUBTILEC all; SURGILEC all				
		LED	All				
		MARTIN	Series 2000; ELECTROM 390; 400				
		NEOMED	Series 3000; 3000A; 3002; 3006; 3010; 3020				
		PHILIPS	TS-403				
	RITTER / MDT	SOLID STATE 400; 400 B; 400 SR					
	SIDEVAN	SEB 2					
	SOXIL	BP 2000; X10					
	THACKRAY	T300S					
	TORRY	LEM 300 CST					
030/AL03	non sterile	BIRCHER	771	5 mt	Z12010980	2224049	1 pc
		ESCHMANN	TD400, 411, 411S	male plug			
		KIRTO	800 – 881 (series 76670)	Ø 4 mm.			
		VALLEYLAB	SSE2K, SSE3B, SSE4				
030/AL04	non sterile	VALLEYLAB	Devices without REM device	5 mt	Z12010980	2224053	1 pc
		BOWA		Valleylab			
		CONMED		Terminal			
		ERBE ICC International ERBE VIO International					
030/AL05	non sterile	VALLEYLAB e simili	Apparatus with REMTM type device (REM is a registered trademark of Valleylab) EXCALIBUR	5 mt	Z12010980	2224052	1 pc
		BOWA		universal			
		ASPENLABS		attack			
		CONMED		Valleylab			
		ERBE ICC ERBE VIO		type			

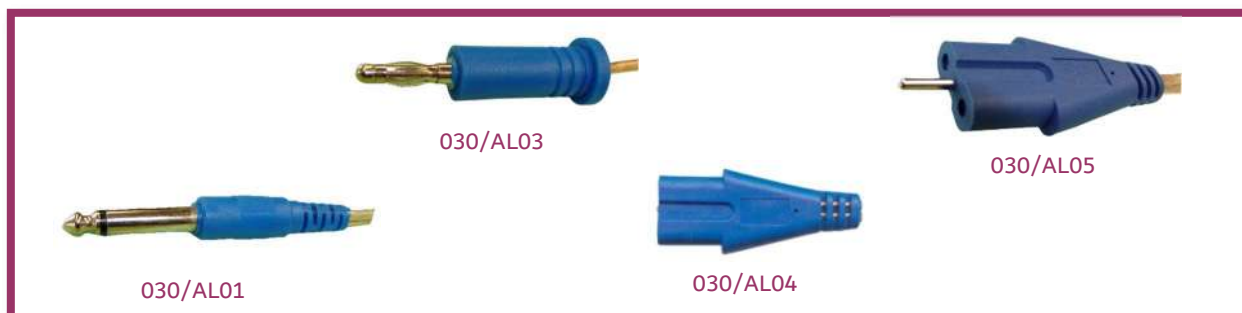

Mono and bipolar electro-surgical forceps | ELECTROSURGERY

The monopolar coagulation forceps is a removable and reusable instrument designed for laparoscopy which allows the tissue to be gripped and cut with simultaneous monopolar coagulation.

CODE		DESCRIPTION	LENGTH CM	TIPS MM	CND	RDM	PACK.
0204-320-100	reusable	ADSON, straight	12,0	1,0	L180401	2627669	1 pc
0204-320-110	reusable	McINDOE, straight	15,0	1,0 - 2,0	L180401	2627669	1 pc
0204-320-120	reusable	GILLES (1x2), straight	15,0	-	L180401	2627669	1 pc
0204-320-122	reusable	GILLES (1x2), straight	17,8	-	L180401	2627669	1 pc
0204-320-124	reusable	GILLES (1x2), straight	20,0	-	L180401	2627669	1 pc
0204-320-126	reusable	GILLES (1x2), straight	23,0	-	L180401	2627669	1 pc
0204-320-130	reusable	POTTS-SMITH, dissecting straight	15,0	1,0 - 2,0	L180401	2627669	1 pc
0204-320-132	reusable	POTTS-SMITH, dissecting straight	17,8	1,0 - 2,0	L180401	2627669	1 pc
0204-320-134	reusable	POTTS-SMITH, dissecting straight	21,0	1,0 - 2,0	L180401	2627669	1 pc
0204-320-136	reusable	POTTS-SMITH, dissecting straight	23,0	1,0 - 2,0	L180401	2627669	1 pc
0204-320-140	reusable	GERALD, straight	17,8	-	L180401	2627669	1 pc
0204-320-150	reusable	ADSON, bayonet	16,0	1,0 - 2,0	L180401	2627669	1 pc
0204-320-152	reusable	ADSON, bayonet	19,1	1,0 - 2,0	L180401	2627669	1 pc
0204-320-160	reusable	ADSON, bayonet angled up	16,0	1,0 - 2,0	L180401	2627669	1 pc
0204-320-162	reusable	ADSON, bayonet angled up	19,1	1,0 - 2,0	L180401	2627669	1 pc
0204-320-164	reusable	ADSON, bayonet angled up	21,0	1,0 - 2,0	L180401	2627669	1 pc
0204-320-170	reusable	REMINGTON HOBBS	24,1	1,0 - 2,0	L180401	2627669	1 pc



0204-320-100 ADSON, STRAIGHT

0204-320-110 McINDOE, STRAIGHT

0204-320-120 GILLES, STRAIGHT

0204-320-130 POTTS-SMITH, STRAIGHT

0204-320-140 GERALD, STRAIGHT

0204-320-150 ADSON, BAYONET

0204-320-160 ADSON, BAYONET
ANGLED UP

0204-320-170 REMINGTON HOBBS



FORCEPS

MONOPOLAR ELECTROSURGICAL

Bipolar forceps are indicated in surgeries that require coagulation and/or cauterization of tissue to promote hemostasis. They are indicated in any kind of surgery.

CODE		DESCRIPTION	LENGTH CM	TIPS MM	CND	RDM	PACK.
0204-310-100	reusable	McPHERSON, straight	10,2	0,5	L180401	2616196	1 pc
0204-310-102	reusable	McPHERSON, straight angled tip	10,2	0,5	L180401	2616196	1 pc
0204-310-110	reusable	JEWELER, straight	11,5	N (ago) - 0,7	L180401	2616196	1 pc
0204-310-112	reusable	JEWELER, straight angled tip	11,5	N (ago) - 0,7	L180401	2616196	1 pc
0204-310-115	reusable	JEWELER, straight curved tip	11,5	N (ago) - 0,7	L180401	2616196	1 pc
0204-310-120	reusable	Straight	15	0,5 - 1 - 2	L180401	2616196	1 pc
0204-310-122	reusable	Straight angled tip	15	0,5 - 1 - 2	L180401	2616196	1 pc
0204-310-130	reusable	Straight	18	0,5 - 1 - 2	L180401	2616196	1 pc
0204-310-132	reusable	Straight angled tip	18	0,5 - 1 - 2	L180401	2616196	1 pc
0204-310-140	reusable	Straight	20	0,5 - 1 - 2	L180401	2616196	1 pc
0204-310-142	reusable	Straight angled tip	20	0,5 - 1 - 2	L180401	2616196	1 pc
0204-310-150	reusable	Straight	22	0,5 - 1 - 2	L180401	2616196	1 pc
0204-310-152	reusable	Straight angled tip	22	0,5 - 1 - 2	L180401	2616196	1 pc
0204-310-260	reusable	Straight	24	0,5 - 1 - 2	L180401	2616196	1 pc
0204-310-262	reusable	Straight angled tip	24	0,5 - 1 - 2	L180401	2616196	1 pc
0204-310-160	reusable	Bayonet	16,5	0,5 - 1 - 2	L180401	2616196	1 pc
0204-310-162	reusable	Bayonet angled tip up	16,5	0,5 - 1 - 2	L180401	2616196	1 pc
0204-310-165	reusable	Bayonet angled tip down	16,5	0,5 - 1 - 2	L180401	2616196	1 pc
0204-310-170	reusable	Bayonet	18	0,5 - 1 - 2	L180401	2616196	1 pc
0204-310-172	reusable	Bayonet angled tip up	18	0,5 - 1 - 2	L180401	2616196	1 pc
0204-310-175	reusable	Bayonet angled tip down	18	0,5 - 1 - 2	L180401	2616196	1 pc
0204-310-180	reusable	Bayonet	20	0,5 - 1 - 2	L180401	2616196	1 pc
0204-310-182	reusable	Bayonet angled tip up	20	0,5 - 1 - 2	L180401	2616196	1 pc
0204-310-185	reusable	Bayonet angled tip down	20	0,5 - 1 - 2	L180401	2616196	1 pc
0204-310-190	reusable	Bayonet	22	0,5 - 1 - 2	L180401	2616196	1 pc
0204-310-200	reusable	Bayonet	24	0,5 - 1 - 2	L180401	2616196	1 pc
0204-310-205	reusable	Bayonet angled tip	24	0,5 - 1 - 2	L180401	2616196	1 pc



0204-310-110-N STRAIGHT



0204-310-140-20 STRAIGHT



0204-310-115-N STRAIGHT CURVED TIP



0204-310-122-10 STRAIGHT ANGLED TIP



0204-310-170-05 BAYONET



0204-310-172-05 BAYONET ANGLED TIP UP



0204-310-185-20 BAYONET ANGLED TIP DOWN



0204-310-200-10 BAYONET

Cables for electrosurgical forceps | ELECTROSURGERY

CABLES FOR MONOPOLAR FORCEPS

CODE	DESCRIPTION	LENGTH	CND	RDM	PACK.
030/AL43	reusable plug cable Ø 4 mm	3 mt	K02010203	45130	1 pc
030/AL83	reusable plug cable Ø 8 mm	3 mt	K02010203	45130	1 pc
030/AL85	reusable plug cable Ø 8 mm	5 mt	K02010203	45130	1 pc



CABLES FOR BIPOLAR FORCEPS

CODE	DESCRIPTION	LENGTH - CONNECTOR	CND	RDM	PACK.
030-190-110 (F7906EU01/3)	reusable European Joint (sled)	3 mt - 2 pin - 4 mm	Z12010980	2581787	1 pc
030-190-110/5 (F7906EU01/5)	reusable European Joint (sled)	5 m - 2 pin - 4 mm	Z12010980	2581788	1 pc
030-190-120 (F7906EU03/3)	reusable European Joint (sled)	3 mt - Martin / Berchtold	Z12010980	2581790	1 pc
030-190-140 (F7906EU02/3)	reusable European Joint (sled)	3 mt - Erbe / Siemens	Z12010980	2581789	1 pc
030-190-140/5 (F7906EU02/5)	reusable European Joint (sled)	5 mt - Erbe / Siemens	Z12010980	2581794	1 pc



030-190-110

JOINT WITH 2 PINS Ø 4 MM for Valleylab, Conmed, Dolley, EMC, Eschmann, Lamidey, GPS, Danieli, GEI.

LED electrosurgical units, and more common brands.



030-190-120

JOINT FOR ELECTROSURGICAL KNIFE
Martin, Berchtold, Wolf

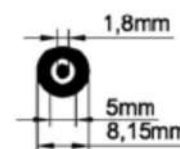

030-190-140

JOINT FOR ELECTROSURGICAL KNIFE

Erbe, Downs, Siemens

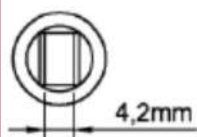
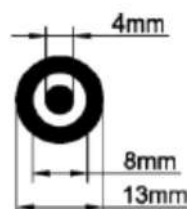

EUROPEAN type forceps
connection terminal

Vases and accessories | SURGICAL ASPIRATION

DISPOSABLE ASPIRATION VASE - 2 LITERS

HOSPITAL'S VACUUM is a system for collecting liquids present in the operating field. The collection vessel is transparent and equipped with a graduated scale in ml for the quantitative and qualitative monitoring of the drained liquid.

CODE		DESCRIPTION	CND	RDM	PACKAGING
0801/NS	non sterile	without tube	A06030401	1754924	25 pcs
0802/NS	non sterile	with 140 cm tube and F/F connector	A06030401	1754924	25 pcs

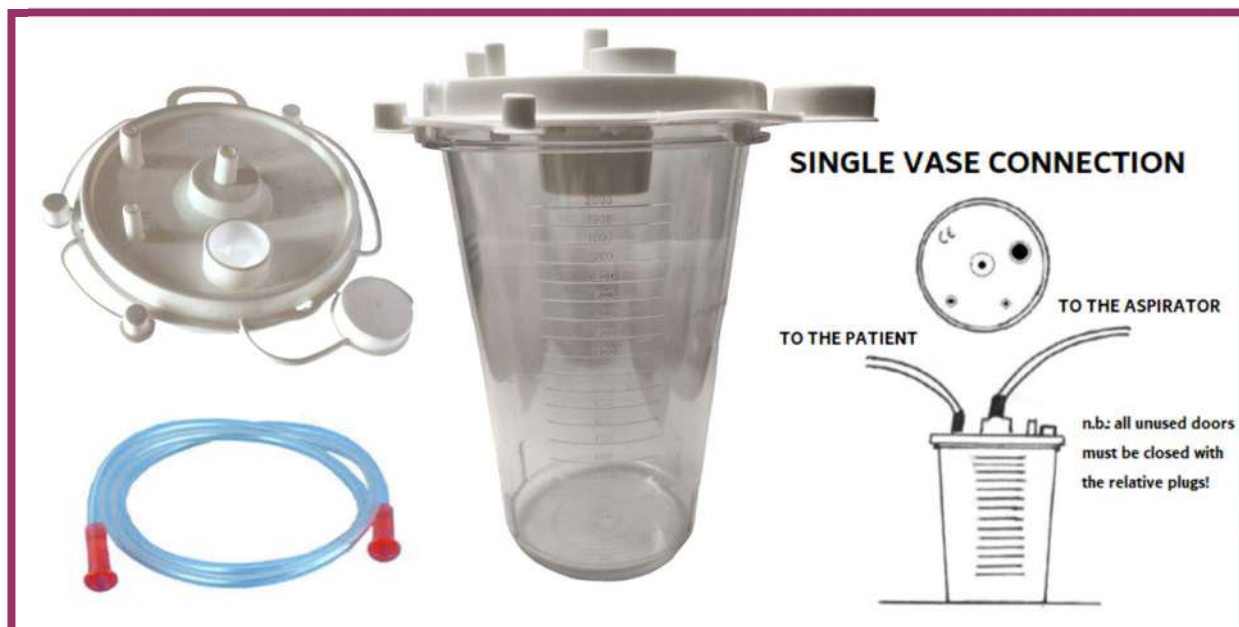

ASPIRATION ACCESSORIES

CODE		DESCRIPTION	CND	RDM	PACKAGING
0805/CP	non sterile	bent connector	N.A.	N.A.	100 pcs
0811	non sterile	4-place flowerpot trolley	N.A.	N.A.	1 pc



Cannulas and tubes | SURGICAL ASPIRATION

CANNULAS FOR SURGICAL ASPIRATION

The Yankauer cannula is indicated for precise aspiration without compromising the visibility of the operating field.

CODE		DESCRIPTION	LENGTH	DIAM. / TIP	CND	RDM	PACK.
8250YACE	sterile	Yankauer type cannula with ergonomic bulb	27 cm	Ø 8 mm / CH32	A06010103	38138	100 pcs
8250YACEV	sterile	Yankauer type cannula with ergonomic bulb with VACUUM CONTROL	27 cm	Ø 8 mm / CH32	A06010103	38138	100 pcs
8250YAE	sterile	Cannula type Yankauer standard ergonomic tip	27 cm	Ø 8 mm / CH24	A06010103	38138	100 pcs
8250YAEV	sterile	Cannula type Yankauer standard ergonomic tip with VACUUM CONTROL	27 cm	Ø 8 mm / CH24	A06010103	38138	100 pcs



TUBES FOR SURGICAL ASPIRATION

The suction tube is compatible with all Yankauer cannula models, ends on both sides with female connectors.

CODE		DESCRIPTION	LENGTH	DIAM.	CND	RDM	PACK.
6090210FF	sterile	Medical PVC tubing for intraoperative aspiration with 2 female connectors	210 cm	6 x 9 mm	A060102	45338	50 pcs
6090300FF	sterile	Medical PVC tubing for intraoperative aspiration with 2 female connectors	300 cm	6 x 9 mm	A060102	45338	50 pcs



KIT COMPOSED OF YANKAUER CANNULA WITH BULB AND TUBE FOR ASPIRATION

CODE		DESCRIPTION	CANNULA LENGTH	TUBE LENGTH	CND	RDM	PACK.
YACE210	sterile	Ergonomic bulb w/o vacuum control	25 cm	210 cm	A06010103	2615997	50 pcs
YACEV210	sterile	Ergonomic bulb WITH VACUUM CONTROL	25 cm	210 cm	A06010103	2615997	50 pcs
YAE210	sterile	Standard tip w/o vacuum control	25 cm	210 cm	A06010103	2615997	50 pcs
YAEV210	sterile	Standard tip WITH VACUUM CONTROL	25 cm	210 cm	A06010103	2615997	50 pcs
YACE300	sterile	Ergonomic bulb w/o vacuum control	25 cm	300 cm	A06010103	2615997	50 pcs
YACEV300	sterile	Ergonomic bulb WITH VACUUM CONTROL	25 cm	300 cm	A06010103	2615997	50 pcs
YAE300	sterile	Standard tip w/o vacuum control	25 cm	300 cm	A06010103	2615997	50 pcs
YAEV300	sterile	Standard tip WITH VACUUM CONTROL	25 cm	300 cm	A06010103	2615997	50 pcs



Mask and goggles | OXYGEN THERAPY

The goal of oxygen therapy is to improve tissue oxygenation, reduce respiratory effort, reduce cardiac effort in heart patients and increase survival.

CODE		DESCRIPTION	SIZE	TUBE LENGTH	CND	RDM	PACK.
OXY01	sterile	mask with elastic band and metal band	adult	2 mt	R03010201	1004926	100 pcs
OXY01-P	sterile	mask with elastic band and metal band	pediatric	2 mt	R03010201	1004926	100 pcs



The “Venturi” regulator has 6 diluters for the oxygen concentration as follows: blue 24%, yellow 28%, white 31%, green 35%, pink 40%, orange 50%.

CODE		DESCRIPTION	SIZE	TUBE LENGTH	CND	RDM	PACK.
OXY02	sterile	mask with kit of colored fittings for variation of oxygen concentration	adult	2 mt	R03010202	2438929	100 pcs
OXY02-P	sterile	mask with kit of colored fittings for variation of oxygen concentration	pediatric	2 mt	R03010202	2438929	100 pcs



The mask with reservoir is a low-flow device made up of a simple mask and a "lung bag" (reservoir) which has the advantage of being able to deliver oxygen with a concentration (FIO2) close to 90%.

CODE		DESCRIPTION	SIZE	TUBE LENGTH	CND	RDM	PACKAGING
OXY03	sterile	mask with reservoir bag	adult	2 mt	R03010201	2438954	100 pcs
OXY03-P	sterile	mask with reservoir bag	pediatric	2 mt	R03010201	1006706	100 pcs



Aerosol therapy is a drug administration technique, used above all for the treatment or prevention of colds, inflammation and infections of the airways.

CODE		DESCRIPTION	SIZE	TUBE LENGTH	CND	RDM	PACKAGING
OXY04	sterile	mask with 60 ml nebuliser and connecting tube	adult	2 mt	R03010301	2436751	100 pcs
OXY04-P	sterile	mask with 60 ml nebuliser and connecting tube	pediatric	2 mt	R03010201	1006726	100 pcs



The nasal cannula allows the patient to talk, eat or drink, leaving good comfort for the duration of use.

CODE	DESCRIPTION	SIZE	TUBE LENGTH	CND	RDM	PACK.
TB01	sterile goggles with attachment for nostrils	adult	2 mt	R03010301	2436751	100 pcs
TB01-P	sterile goggles with attachment for nostrils	pediatric	2 mt	R03010201	1006726	100 pcs

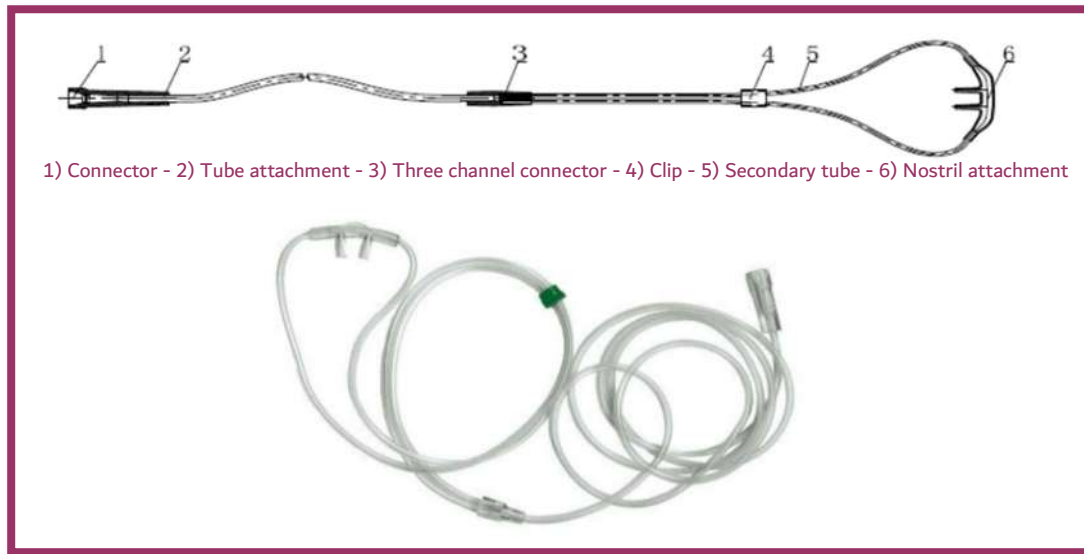

The nasal cannula consists of two small tubes to be inserted into the nose and fixed thanks to their passage behind the ears and under the chin, where the tube is joined to a cannula, which, in turn, is connected to the oxygen supply source like a tank of oxygen in gaseous form (cylinder).

CODE	DESCRIPTION	TUBE LENGTH	DIAMETER	CND	RDM	PACKAGING
PR02	sterile connector tube and joint fitting	300 cm	Tube: Ø 0,5 cm Joint: Ø 0,8 cm	R03010303	2436753	100 pcs

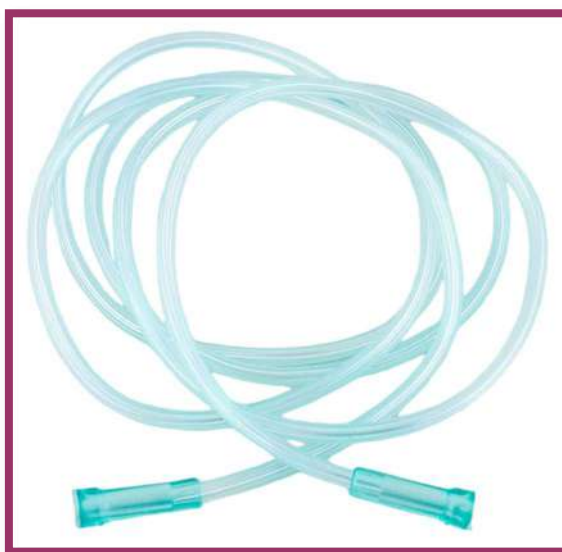

Pep Mask | RESPIRATORY THERAPY

PEP/RMT™ SET WITH FACIAL MASK

The PEP MASK is a fundamental medical device for respiratory rehabilitation. The set consists of: mask, case, valve, resistors.

CODE		DESCRIPTION	SIZE	CND	RDM	PACK.
71100	reusable	Newborn size set	70 mm x 60 mm x 48 mm	Y030327	1957516	1 pc
71101	reusable	Child size set	85 mm x 71 mm x 48,3 mm	Y030327	1957517	1 pc
71102	reusable	Teen size set	101 mm x 80 mm x 70 mm ± 5 mm	Y030327	1957518	1 pc
71103	reusable	Adult size set	115 mm x 90 mm x 80 mm ± 5mm	Y030327	1957184	1 pc
71104	reusable	Large adult size set	125 mm x 100 mm x 83 mm ± 5mm	Y030327	1957523	1 pc
71108	reusable	Set with mouthpiece	---	Y030327	1957532	1 pc



PEP/RMT™ FACIAL MASK

It is a method based on the application of resistance to the mouth in the expiratory phase, which, by generating a Positive Expiratory Pressure (P.E.P.) within the airways, prevents their collapse and guarantees the activation of the collateral circulation.

CODE		DESCRIPTION	SIZE	CND	RDM	PACK.
71110	reusable	Newborn size set	70 mm x 60 mm x 48 mm	Y030327	1963530	1 pc
71111	reusable	Child size set	85 mm x 71 mm x 48,3 mm	Y030327	1958709	1 pc
71112	reusable	Teen size set	101 mm x 80 mm x 70 mm ± 5 mm	Y030327	1958712	1 pc
71113	reusable	Adult size set	115 mm x 90 mm x 80 mm ± 5mm	Y030327	1958724	1 pc
71114	reusable	Large adult size set	125 mm x 100 mm x 83 mm ± 5mm	Y030327	1958726	1 pc



Pep Mask accessories | RESPIRATORY THERAPY

PEP/RMT™ ACCESSORIES

Pep Mask replacements are essential to maintaining the effectiveness of respiratory therapy masks.

CODE	DESCRIPTION	CND	RDM	PACK.
71109	3 pieces mouthpiece	Y030327	1958948	3 pcs
71119	PEP/RMT™ valve	Y030327	1961085	1 pc
71120	Set with 8 resistors: 1.5mm black + 2mm white + 2.5mm yellow + 3mm blue + 3.5 green + 4mm orange + 5mm brown	Y030327	1961207	1 pc
71130	PEP/RMT™ pressure gauge -100 / +150 cm H ₂ O	Y030327	1958950	1 pc
71131	PEP/RMT™ pressure gauge -30 / +30 cm H ₂ O	Y030327	1957197	1 pc
71132	T-connector for pressure gauge	Y030327	1957187	1 pc



Tracheostomy cannulas | OTOLARYNGOLOGY

Tracheostomy tubes are mainly used to connect the stoma, i.e. the hole created, to the mechanical ventilation machines that support the patient's breathing, which is no longer autonomous.

CUFFED TRACHEOSTOMY CANNULA

MODEL C: CANNULA, STYLET, INTERNAL CANNULA AND 2 FIXING BANDS

CODE		LENGTH	INTERNAL DIAMETER	EXTERNAL DIAMETER	CND	RDM	PACKAGING
CHTT5C	sterile	55 mm	Ø 5 mm	Ø 8,6 mm	R01050201	1377509	1 pc
CHTT6C	sterile	64 mm	Ø 6 mm	Ø 9,7 mm	R01050201	1377509	1 pc
CHTT7C	sterile	70 mm	Ø 7 mm	Ø 10,8 mm	R01050201	1377509	1 pc
CHTT8C	sterile	75 mm	Ø 8 mm	Ø 12 mm	R01050201	1377509	1 pc
CHTT9C	sterile	78 mm	Ø 9 mm	Ø 13,2 mm	R01050201	1377509	1 pc



UNCUFFED TRACHEOSTOMY CANNULA

MODEL NC: CANNULA, STYLET, 2 INTERNAL CANNULA AND 2 FIXING BANDS

CODE		LENGTH	INTERNAL DIAMETER	EXTERNAL DIAMETER	CND	RDM	PACKAGING
CHTT5NC	sterile	55 mm	Ø 5 mm	Ø 8,6 mm	R01050101	1377499	1 pc
CHTT6NC	sterile	64 mm	Ø 6 mm	Ø 9,7 mm	R01050101	1377499	1 pc
CHTT7NC	sterile	70 mm	Ø 7 mm	Ø 10,8 mm	R01050101	1377499	1 pc
CHTT8NC	sterile	75 mm	Ø 8 mm	Ø 12 mm	R01050101	1377499	1 pc
CHTT9NC	sterile	78 mm	Ø 9 mm	Ø 13,2 mm	R01050101	1377499	1 pc



CUFFED TRACHEOSTOMY CANNULA WITH FENESTRATE

MODEL CF/A: CANNULA, STYLET, 3 INTERNAL CANNULA AND 2 FIXING BANDS

CODE		LENGTH	INTERNAL DIAMETER	EXTERNAL DIAMETER	CND	RDM	PACKAGING
CHTT5CF/A	sterile	55 mm	Ø 5 mm	Ø 8,6 mm	R01050201	1378189	1 pc
CHTT6CF/A	sterile	64 mm	Ø 6 mm	Ø 9,7 mm	R01050201	1378189	1 pc
CHTT7CF/A	sterile	70 mm	Ø 7 mm	Ø 10,8 mm	R01050201	1378189	1 pc
CHTT8CF/A	sterile	75 mm	Ø 8 mm	Ø 12 mm	R01050201	1378189	1 pc
CHTT9CF/A	sterile	78 mm	Ø 9 mm	Ø 13,2 mm	R01050201	1378189	1 pc



UNCUFFED TRACHEOSTOMY CANNULA WITH FENESTRATE

MODEL F/A: CANNULA, STYLET, 3 INTERNAL CANNULA, 2 CAPS AND 2 FIXING BANDS

CODE		LENGTH	INTERNAL DIAMETER	EXTERNAL DIAMETER	CND	RDM	PACKAGING
CHTT5F/A	sterile	55 mm	Ø 5 mm	Ø 8,6 mm	R01050101	1378198	1 pc
CHTT6F/A	sterile	64 mm	Ø 6 mm	Ø 9,7 mm	R01050101	1378198	1 pc
CHTT7F/A	sterile	70 mm	Ø 7 mm	Ø 10,8 mm	R01050101	1378198	1 pc
CHTT8F/A	sterile	75 mm	Ø 8 mm	Ø 12 mm	R01050101	1378198	1 pc
CHTT9F/A	sterile	78 mm	Ø 9 mm	Ø 13,2 mm	R01050101	1378198	1 pc



CUFFED TRACHEOSTOMY CANNULA WITH ASPIRATION LINE

MODEL C-S: CANNULA, STYLET, INTERNAL CANNULA, ASPIRATION LINE AND 2 FIXING BANDS

CODE		LENGTH	INTERNAL DIAMETER	EXTERNAL DIAMETER	CND	RDM	PACKAGING
CHTT5C-S	sterile	55 mm	Ø 5 mm	Ø 8,6 mm	R01050201	1376532	1 pc
CHTT6C-S	sterile	64 mm	Ø 6 mm	Ø 9,7 mm	R01050201	1376532	1 pc
CHTT7C-S	sterile	70 mm	Ø 7 mm	Ø 10,8 mm	R01050201	1376532	1 pc
CHTT8C-S	sterile	75 mm	Ø 8 mm	Ø 12 mm	R01050201	1376532	1 pc
CHTT9C-S	sterile	78 mm	Ø 9 mm	Ø 13,2 mm	R01050201	1376532	1 pc



CUFFED TRACHEOSTOMY CANNULA WITH FENESTRATE WITH ASPIRATION LINE

MODEL CF-S/A: CANNULA, STYLET, 3 INTERNAL CANNULAS, 2 CAPS, ASPIRATION LINE AND 2 FIXING BANDS

CODE		LENGTH	INTERNAL DIAMETER	EXTERNAL DIAMETER	CND	RDM	PACKAGING
CHTT5CF-S/A	sterile	55 mm	Ø 5 mm	Ø 8,6 mm	R01050201	1378194	1 pc
CHTT6 CF-S/A	sterile	64 mm	Ø 6 mm	Ø 9,7 mm	R01050201	1378194	1 pc
CHTT7 CF-S/A	sterile	70 mm	Ø 7 mm	Ø 10,8 mm	R01050201	1378194	1 pc
CHTT8 CF-S/A	sterile	75 mm	Ø 8 mm	Ø 12 mm	R01050201	1378194	1 pc
CHTT9 CF-S/A	sterile	78 mm	Ø 9 mm	Ø 13,2 mm	R01050201	1378194	1 pc



NEONATE TRACHEOSTOMY CANNULA

MODEL N: CANNULA, STYLET AND FIXING BAND

CODE		LENGTH	INTERNAL DIAMETER	EXTERNAL DIAMETER	CND	RDM	PACKAGING
CHTT3N	sterile	30 mm	Ø 3 mm	Ø 4,5 mm	R01050101	1378201	1 pc
CHTT3,5N	sterile	32 mm	Ø 3,5 mm	Ø 5,2 mm	R01050101	1378201	1 pc
CHTT4N	sterile	34 mm	Ø 4 mm	Ø 5,9 mm	R01050101	1378201	1 pc



PEDIATRIC TRACHEOSTOMY CANNULA

MODEL P: CANNULA, STYLET AND 2 FIXING BANDS

CODE		LENGTH	INTERNAL DIAMETER	EXTERNAL DIAMETER	CND	RDM	PACKAGING
CHTT3P	sterile	39 mm	Ø 3 mm	Ø 4,5 mm	R01050101	1378203	1 pc
CHTT3,5P	sterile	40 mm	Ø 3,5 mm	Ø 5,2 mm	R01050101	1378203	1 pc
CHTT4P	sterile	41 mm	Ø 4 mm	Ø 5,9 mm	R01050101	1378203	1 pc
CHTT4,5P	sterile	42 mm	Ø 4,5 mm	Ø 6,9 mm	R01050101	1378203	1 pc
CHTT5P	sterile	44 mm	Ø 5 mm	Ø 7,1 mm	R01050101	1378203	1 pc
CHTT5,5P	sterile	46 mm	Ø 5,5 mm	Ø 7,7 mm	R01050101	1378203	1 pc



Cannula accessories | OTOLARYNGOLOGY

The cannula, which keeps the tracheostomy open allowing normal breathing. The curved/angled part of the tube is placed in the trachea, while the flange is placed on the outside.

INTERNAL CANNULA

FENESTRATED

Internal Diameter from 5 to 9 mm
Code **CHTTx-IF**
CND R01050101 - RDM 1378204
PACKAGING of 5 pcs



INTERNAL CANNULA

FENESTRATED WITH

CONNECTOR mm15

Internal Diameter from 5 to 9 mm
Code **CHTTx-IF/A**
CND R01050101 - RDM 1378209
PACKAGING of 5 pcs



INTERNAL CANNULA

FENESTRATED WITH

PHONATORY VALVE

Internal Diameter from 5 to 9 mm
Code **CHTTx-IF/V**
CND R01050101 - RDM 1378210
PACKAGING of 5 pcs

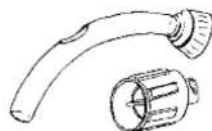

LOW PROFILE INTERNAL

CANNULA

Internal Diameter from 5 to 9 mm
Code **CHTTx-IC/LP**
CND R01050101 - RDM 1378207
PACKAGING of 5 pcs

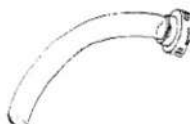

INTERNAL CANNULA WITH

CONNECTOR 15mm

Internal Diameter from 5 to 9 mm
Code **CHTTx-IC/HP**
CND R01050101 - RDM 1378208
PACKAGING of 5 pcs

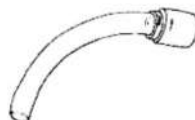

PIPE CLEANER

Non sterile
Code **CHTT-BR**
CND R010580 - RDM 1376537
PACKAGING of 10 pcs



PIPE CLEANER

Sterile
Code **CHTT-BRS**
CND R010580 - RDM 1476927
PACKAGING of 25 pcs



FIXING BAND – UNIVERSAL

SIZE (380 mm x 23 mm x 5 mm)

Sterile
Code **CHTT-COLL01**
CND R010580 - RDM 1476929
PACKAGING of 5 pcs



DECANNULATION CAP

Code **CHTTRC**
CND R010580 - REP 1476924
PACKAGING of 5 pcs



CLOSING CAP

WITH CONNECTOR 15mm

Code **CHTTBC**
CND R010580 - RDM 1476925
PACKAGING of 5 pcs



PHONATORY VALVE

Code **CHTTSV**
CND R010580 - RDM 1476923
PACKAGING of 5 pcs



FIXING BAND – 3 SIZES

CODE		DESCRIPTION	SIZE	CND	RDM	PACK.
CHTT-COLL01-SNS	Non sterile	Fixing band size S	420 mm x 35 mm x 6 mm	R01058001	2368606	10 pcs
CHTT-COLL01-MNS	Non sterile	Fixing band size M	454 mm x 35 mm x 6 mm	R01058001	2368606	10 pcs
CHTT-COLL01-LNS	Non sterile	Fixing band size L	500 mm x 35 mm x 6 mm	R01058001	2368606	10 pcs

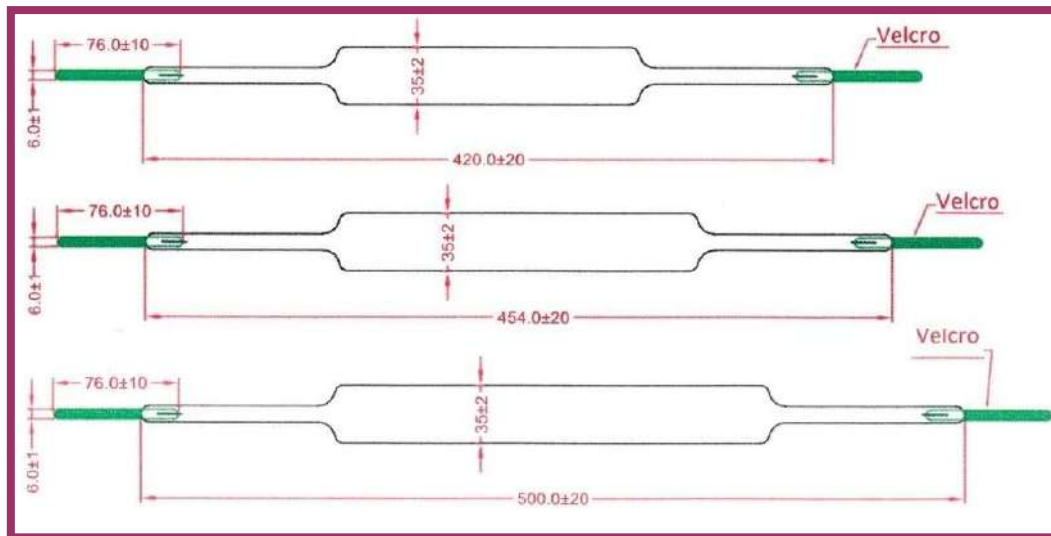

E.C.G. electrodes and gel | ULTRASOUND

ELECTRODES FOR E.C.G. BUTTON, WITH FOAM SUPPORT AND SEMI-LIQUID GEL

The button electrodes have a face without gel, the one not in contact with the patient's skin, a protuberance that fits inside the recess on the terminal of the patient cable. The size allows you to stimulate a larger area and obtain maximum effectiveness from electrocardiograms.

CODE		DESCRIPTION	SIZE	CND	RDM	BOX
LF50	non sterile	Semi-liquid gel round ECG electrode	Ø 50 mm	C020501	210146	1000 pcs
LF40	non sterile	Semi-liquid gel square ECG electrode	42x32 mm	C020501	210146	2000 pcs
SF40	non sterile	Solid gel square ECG electrode	42x32 mm	C020501	N.D.	2500 pcs

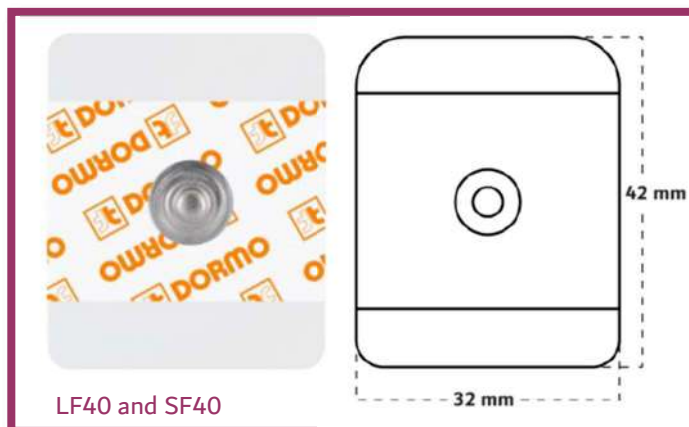

GEL FOR ELECTRODES SPECTRA® 360 - PARKER

Product designed for conductive rubber/carbon electrodes with the non-grainy STAY-WET® formula that allows extended use without reapplication. Designed for ECG, TENS, monitoring and pediatrics; it's not recommended for defibrillation.

CODE		QUANTITY	CND	RDM	BOX
12-08	non sterile	250 gr	V9099	128283	12 pcs



Gel for ultrasound | ULTRASOUND

ULTRASOUND GEL SQUEEZABLE BOTTLE WITH PUSH-PULL UP DISPENSER CAP

ULTRAGEL is a gel designed for use in physiotherapy and ultrasound diagnostics. The product is not formulated for direct use on mucous membranes.



CODE		QUANTITY	CND	RDM	BOX
UG250	non sterile	260 ml	V9099	7331	35 pcs
UG1000	non sterile	1000 ml	V9099	2525676	12 pcs
UG5000C	non sterile	5000 ml	V9099	2525676	2 pcs - Cubitainer of 5 liters with nr 1 bottle of 260 ml

TRANSPARENT GEL FOR ULTRASOUND AND PULSED LIGHT SQUEEZABLE BOTTLE WITH PUSH-PULL UP DISPENSER CAP

ULTRAGEL guarantees the transmission of ultrasound in different fields of application.



CODE		QUANTITY	CND	RDM	BOX
UG250T	non sterile	260 ml	V9099	2525671	36 pcs
UG1000T	non sterile	1000 ml	V9099	2525671	12 pcs
UG5000CT	non sterile	5000 ml	V9099	2525671	2 pcs - Cubitainer of 5 liters with nr 1 bottle of 260 ml

TRANSPARENT STERILE GEL TRANSONIC® ULTRASOUND TRANSMISSION GEL

The ultrasound gel is used to improve the electrical conductivity between the patient's body and the electrodes where product sterility is required.



CODE		QUANTITY	CND	RDM	BOX
G-15E	sterile	20 ml	V9099	48682	48 pcs

ULTRASOUND GEL ACQUASONIC® 100 - PARKER

Ultrasound gel is a special medical gel used for Doppler, physiotherapy, electromedical examinations and ultrasounds.



CODE		COLOUR	QUANTITY	CND	RDM	BOX
01-01	sterile	Light blue	20 gr	V9099	125280	48 pcs
01-08	non sterile	Light blue	0,25 lt	V9099	2398666	12 pcs
01-50	non sterile	Light blue	5 lt	V9099	2398665	4 pcs
03-50	non sterile	Transparent	5 lt	V9099	2398660	4 pcs

Sony paper and printers | ULTRASOUND

Ultrasound is a non-invasive diagnostic method that uses ultrasound to visualize organs, glands, blood vessels, subcutaneous structures and even muscle and tendon structures in many parts of the body.

ORIGINAL SONY PAPER FOR BLACK/WHITE PRINTERS - A4 FORMAT

CODE	DESCRIPTION	CND	RDM	BOX
UPP210HD	B/W paper type 2 – A4 format used on printers UP-991AD, UP-990AD, UP-971AD, UP-970AD	Z1302	86416	20 rolls



ORIGINAL SONY PAPER FOR BLACK/WHITE PRINTERS - A6 FORMAT

CODE	DESCRIPTION	CND	RDM	BOX
UPP110S	B/W paper, high density type 1 – A6 format used on printers UP-895CE, UP-D895, UP-890CE, UP-890, UP-860CE, UP-D860	Z1302	86371	Pack. of 10 rolls Box of 100 rolls
UPP110HD	B/W paper, high density type 2 – A6 format used on printers UP-895CE, UP-D895, UP-890CE, UP-D890, UP-860CE, UP-D860	Z1302	86110	Pack. of 10 rolls Box of 100 rolls
UPP110HA	B/W paper, high density type 4 – A6 format used on printers UP-890CE, UP-D890	Z1302	86053	Box of 100 rolls Box of 100 rolls
UPP110HG	B/W paper, high density type 5 – A6 format used on printers UP-895CE, UP-D895	Z1302	86161	Pack. of 10 rolls Box of 100 rolls



ORIGINAL SONY PAPER FOR BLACK/WHITE PRINTERS - A7 FORMAT

CODE	DESCRIPTION	CND	RDM	BOX
UPP84HG	B/W paper, high density type HG – A7 format used on printer UP-D711MD	Z1302	831025	100 rolls
UPP84S	B/W paper, high density type S – A7 format used on printer UP-D711MD	Z1302	831055	100 rolls



ORIGINAL SONY PAPER FOR COLOR PRINTERS - A4/A6/A7 FORMAT

CODE	DESCRIPTION	CND	RDM	BOX
UPCSR80MD	Self-laminating color paper in pack of 2 rolls of 50 sheets each – A4 format used on printer UP-DR80MD	Z1302	127748	4 rolls
UPCS21L	Color paper in pack of 200 sheets of print media, 4 color ink tapes – A6 format used on printer UP-25MD, UP-27MD, UP-D25MD.	Z1302	86517	6 packages
UPCS21S	Color paper in a pack of 240 print supports, 3 color ink tapes – A7 used on printer UP-25MD, UP-27MD, UP-D25MD.	Z1302	86463	6 packages



SONY PRINTERS FOR ULTRASOUND PAPER

CODE	DESCRIPTION	CND	RDM	BOX
UP-X898MD	Sony BLACK/WHITE printer analogical and digital A6	Z110706	1153496	1 pc
UP-25MD	Sony COLOR printer medical analogical	Z110706	347665	1 pc
UP-D25MD	Sony COLOR printer medical digital	Z110706	306367	1 pc



UP-X898MD



UP-25MD



UP-D25MD

Mitsubishi paper | ULTRASOUND

Ultrasound paper is mainly used for diagnostic examinations with ultrasound applications.

ORIGINAL MITSUBISHI PAPER FOR BLACK/WHITE PRINTERS - A6 FORMAT

CODE	DESCRIPTION	CND	RDM	BOX
KP61B-CE	B/N paper – A6 format used for photo printers P93W/E and P95DE/DW	Z1302	156372	Pack. of 4 rolls Box of 80 rolls
KP65HM-CE	B/N paper – A6 format used for photo printers P93W/E and P95DE/DW	Z1302	165319	Pack. of 4 rolls Box of 80 rolls



ALPHABETICAL INDEX OF PRODUCTS

Adapters for electrosurgical knife	pag. 20
Aspiration accessories	pag. 31
Bipolar electrosurgical forceps	pag. 29
Cables for bipolar forceps	pag. 30
Cables for monopolar clamps	pag. 30
Cannula accessories	pag. 42
Cannulas for surgical aspiration	pag. 32
Cot roll in pure cellulose 2 ply - Lucart	pag. 15
Cuffed tracheostomy cannula	pag. 38
Cuffed tracheostomy cannula with aspiration line	pag. 40
Cuffed tracheostomy cannula with fenestrate	pag. 39
Cuffed tracheostomy cannula with fenestrate with aspiration line	pag. 40
Decontaminant mats with bit bacteriostatic agents	pag. 14
Diapers soffisof air dry	pag. 17
Disposable anoscope	pag. 14
Disposable aspiration vase - 2 liters	pag. 31
Disposable cannulas for intrauterine aspiration "Karman" method	pag. 10
Disposable cannulas for intrauterine aspiration, rigid curved, flute beak	pag. 10
Disposable cannulas for intrauterine aspiration, rigid straight flute beak	pag. 10
Disposable cervical maturation balloon	pag. 9
Disposable cotton swab for sampling	pag. 7
Disposable endocervical collection brush	pag. 7
Disposable handpiece with CUT-COAG switch	pag. 18
Disposable monopolar foot-pedal handpiece with 4 mm diameter pin	pag. 19
Disposable sterile abrasive sponge	pag. 19

Disposable sterile demographic pen with regular point with ruler	pag. 19
Disposable washing mitten/sponge for patient	pag. 16
Disposable wooden ayre spatulas	pag. 7
Disposable wooden tongue depressor	pag. 13
Electrodes for handpieces - Non-stick with Teflon coating	pag. 24
Electrodes for handpieces – Standard Steel	pag. 21
Electrodes for handpieces - Tungsten Tip	pag. 24
Electrodes for E.C.G. button, with foam support and semi-liquid gel	pag. 44
Endometrial sampling probe, "endocyte" type, disposable sterile	pag. 7
Extension for oxygen therapy	pag. 35
Fixing band - 3 sizes	pag. 43
Gel for electrodes SPECTRA® 360 - PARKER	pag. 44
Goggles for oxygen therapy	pag. 35
Instant ice in bags	pag. 16
Kit composed of Yankauer cannula with bulb and tube for aspiration	pag. 32
Kit with disposable handpiece with CUT-COAG switch	pag. 18
Lubricated probe cover eclipse® - parker	pag. 9
Minicontainer for non-sterile slides	pag. 8
Monopolar electrosurgical forceps	pag. 28
Neonate tracheostomy cannula	pag. 41
Non-lubricated latex probe cover	pag. 8
Original Mitsubishi paper for black/white printers - A6 format	pag. 49
Original Sony paper for black/white printers - A4 format	pag. 46
Original Sony paper for black/white printers - A6 format	pag. 46
Original Sony paper for black/white printers - A7 format	pag. 47
Original Sony paper for color printers - A4/A6/A7 format	pag. 48

Oxygen mask	pag. 33
Oxygen mask for aerosoltherapy	pag. 34
Oxygen mask with “Venturi” regulator	pag. 33
Oxygen mask with reservoir	pag. 34
Pediatric tracheostomy cannula	pag. 41
PEP/RMT™ accessories	pag. 37
PEP/RMT™ facial mask	pag. 36
PEP/RMT™ set with facial mask	pag. 36
Reusable cables for patient plate use	pag. 27
Reusable handpiece with CUT-COAG switch	pag. 18
Reusable monopolar handpiece 30 cycles, foot-pedal with 4 mm diameter pin	pag. 19
Rigid plastic holder for IV	pag. 16
Round or diamond loop	pag. 23
Rubber pessary	pag. 12
Semi-round loop - Length cm. 13	pag. 22
Shoe covers	pag. 14
Silicone pessary	pag. 12
Single-part disposable patient plate adhesive pre-gelled with hydrogel	pag. 25
Slides for cytology, ground and with sandblasted band	pag. 8
Sony printers for ultrasound paper	pag. 48
Spray cytological fixer	pag. 8
Square loop and sail for conization - Length cm. 13	pag. 23
Sterile blue silicone pessary	pag. 12
Sterile disposable amniotic membrane perforator	pag. 6
Sterile disposable hysterometric dilatation probe	pag. 6
Sterile disposable tweezers for medication	pag. 13

Sterile disposable umbilical cord clamp	pag. 6
Sterile endometrial biopsy set	pag. 6
Sterile latex gloves for medication and exploration	pag. 13
Sterile Lubricant Gel COGEL - Comedical	pag. 9
Sterile pap-test	pag. 11
Transparent gel for ultrasound and pulsed light squeezable bottle with push-pull up dispenser cap	pag. 45
Trasparent sterile gel TRANSONIC® ultrasound transmission gel	pag. 45
Tubes for surgical aspiration	pag. 32
Two-part disposable patient plate adhesive pre-gelled with hydrogel	pag. 25
Ultrasuond gel ACQUASONIC® 100 - PARKER	pag. 45
Ultrasuond gel squeezable bottle with push-pull up dispenser cap	pag. 45
Uncuffed tracheostomy cannula	pag. 38
Uncuffed tracheostomy cannula with fenestrate	pag. 39
Universal pregelled adhesive two-part disposable patient plate	pag. 26
Vaginal speculum - Central pin adjustment model	pag. 5
Vaginal speculum - Serrated central pin model	pag. 5
Vaginal speculum - Side screw gradual adjustment model	pag. 5

“Of life's two chief prizes, beauty
and truth, I found the first in a
loving heart and the second in a
laborer's hand.”

Khalil Gibran